



Aart Strootman Mmus Mmus MA

*Creative performer |
Performing creative*



TWO PAGES



'nodes in a socio-technical assemblage'

Trevor Pinch 2019: 4

Composer



Performer

Composer



Performer

Instrument

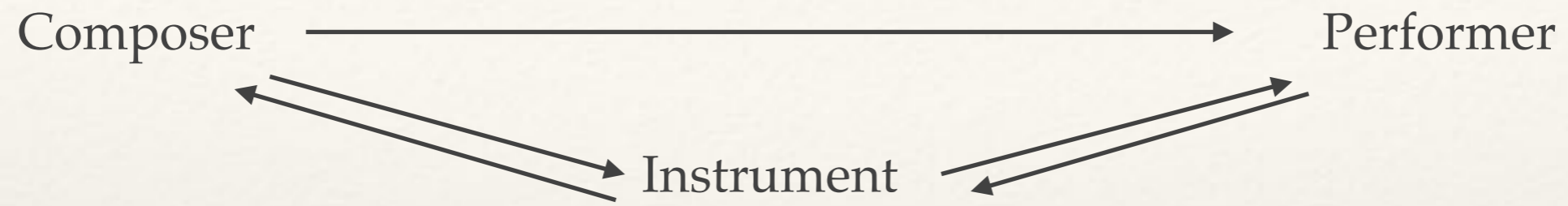

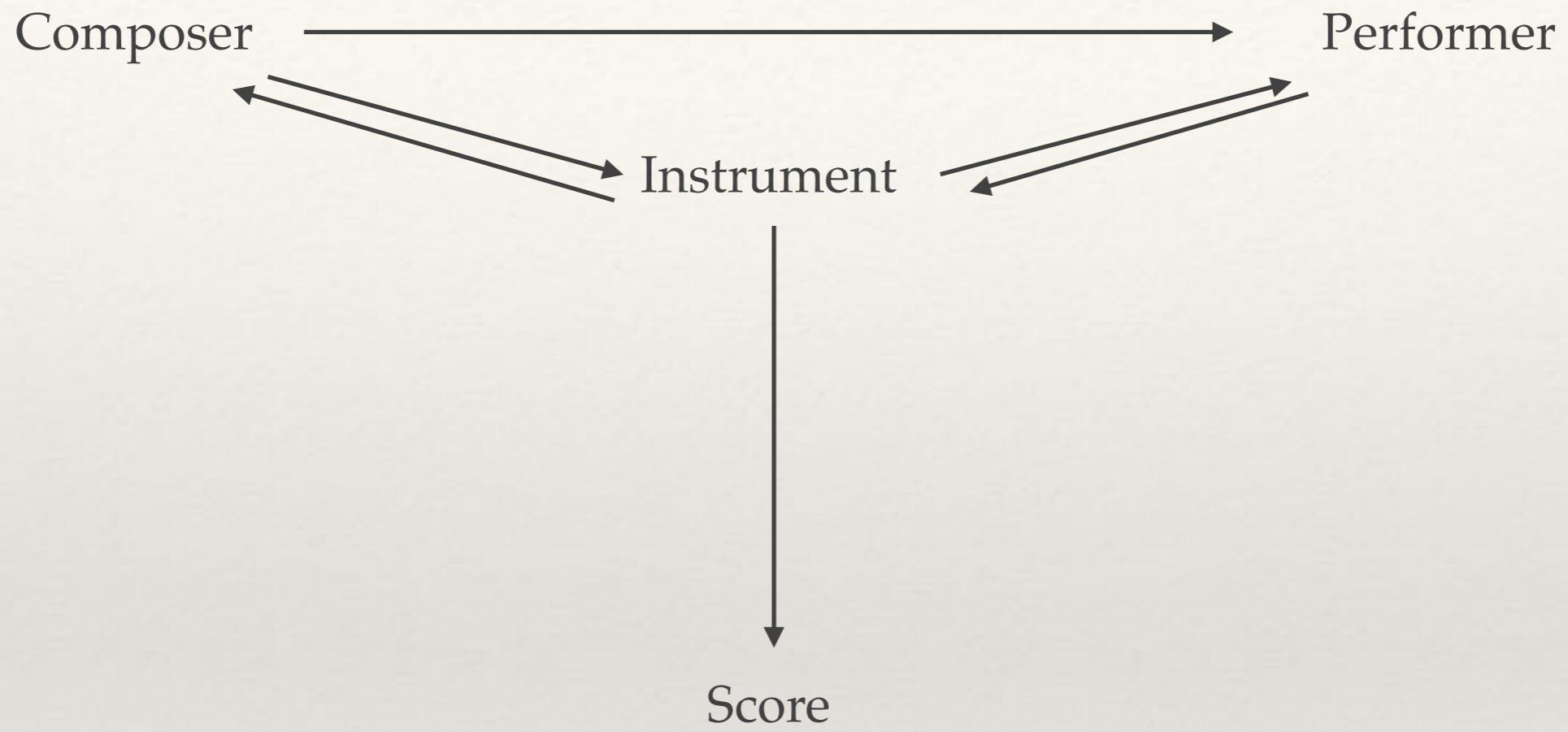

Composer

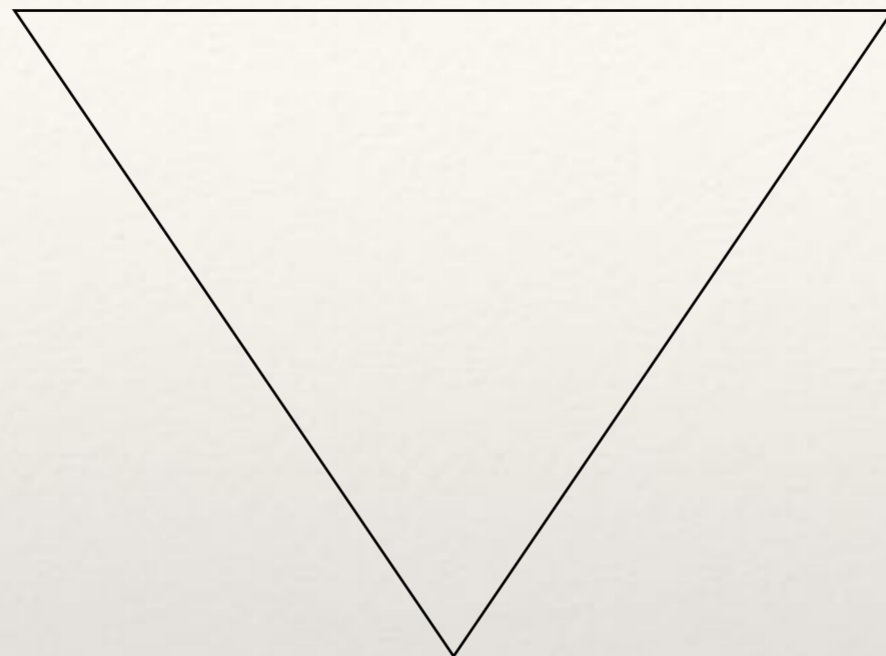

Performer

Luthier

Feedback loop:

Composer:
Musical ideas

Performer:
Technicality

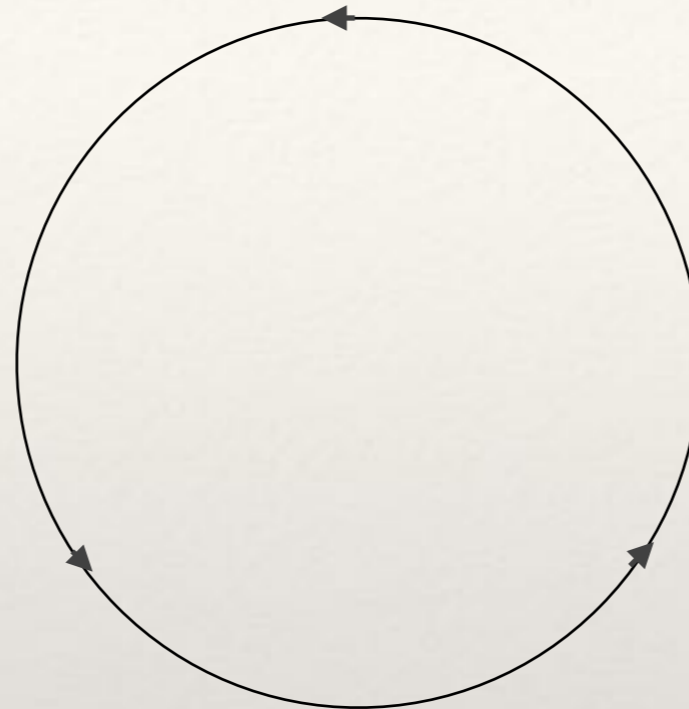

Luthier:
Physical instrument

Creative performer
Performing creative

Musical ideas

Technicality

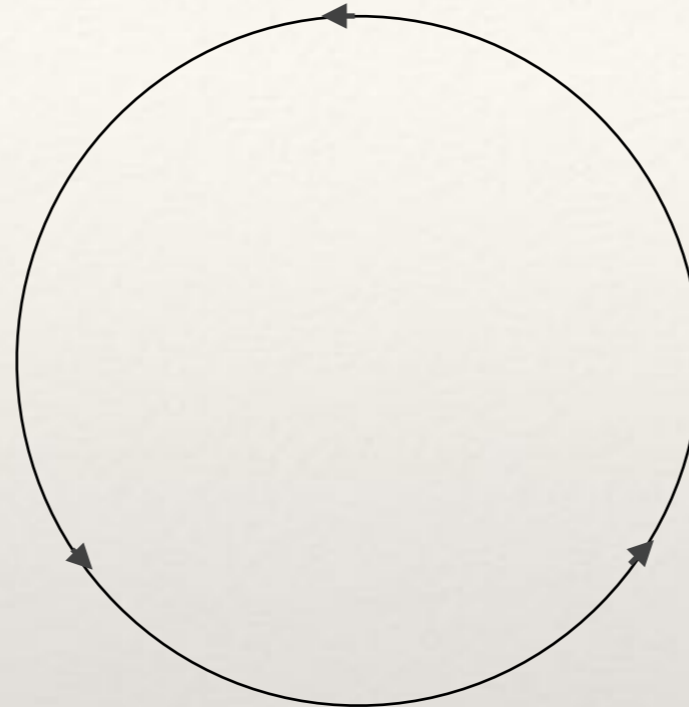

Physical instrument

Harry Partch

Diamond Marimba

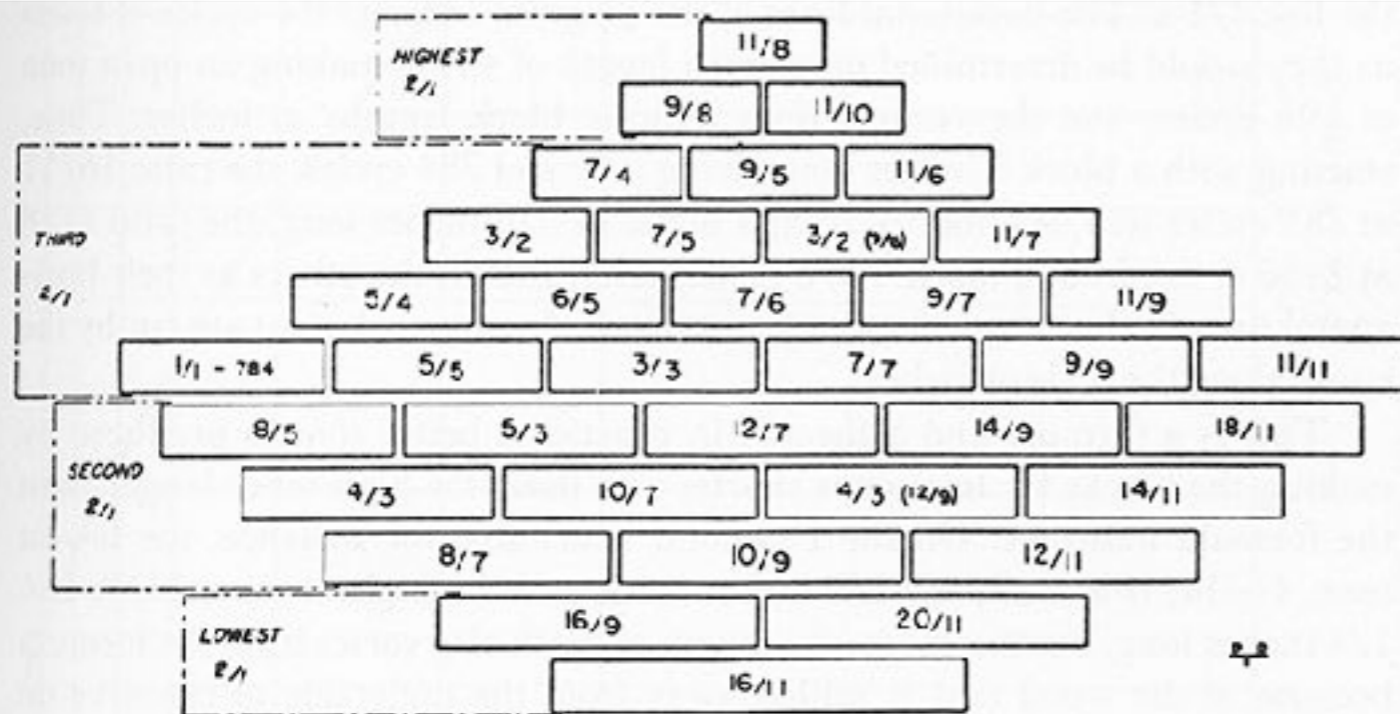
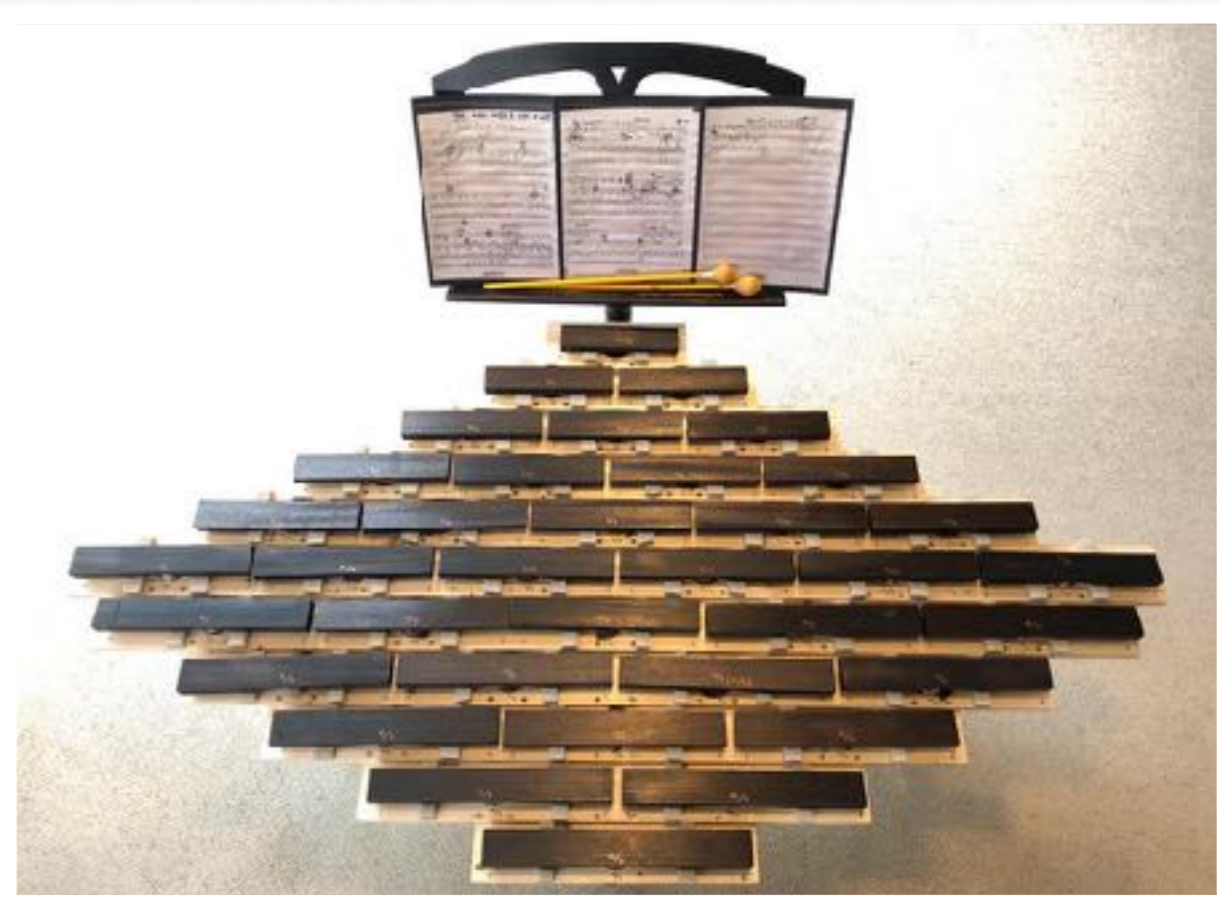

DIAGRAM 17.—BLOCK PLAN OF THE DIAMOND MARIMBA



TWO PAGES



Case study 1:



Composer

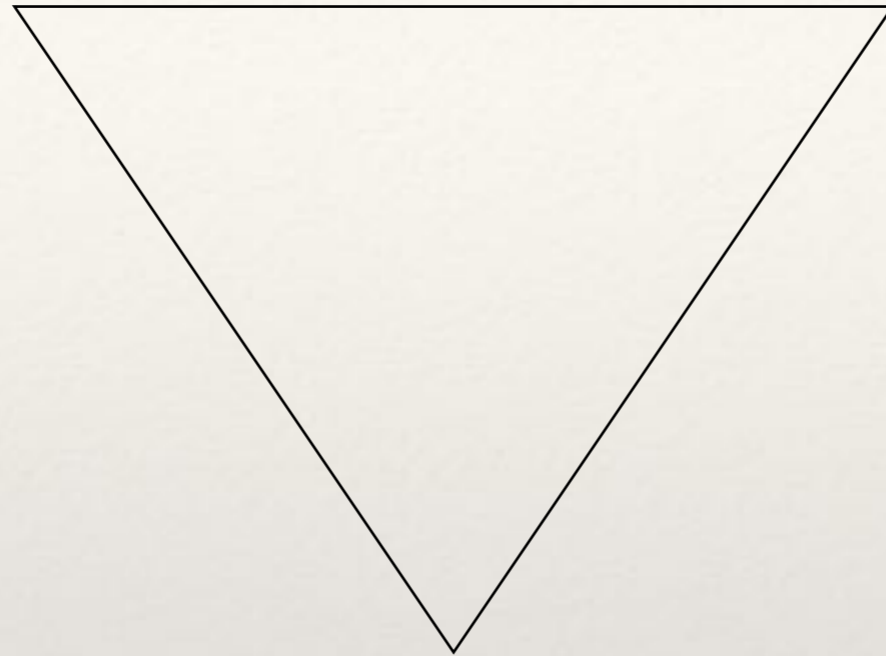

Performer

Luthier

Katherine Teng

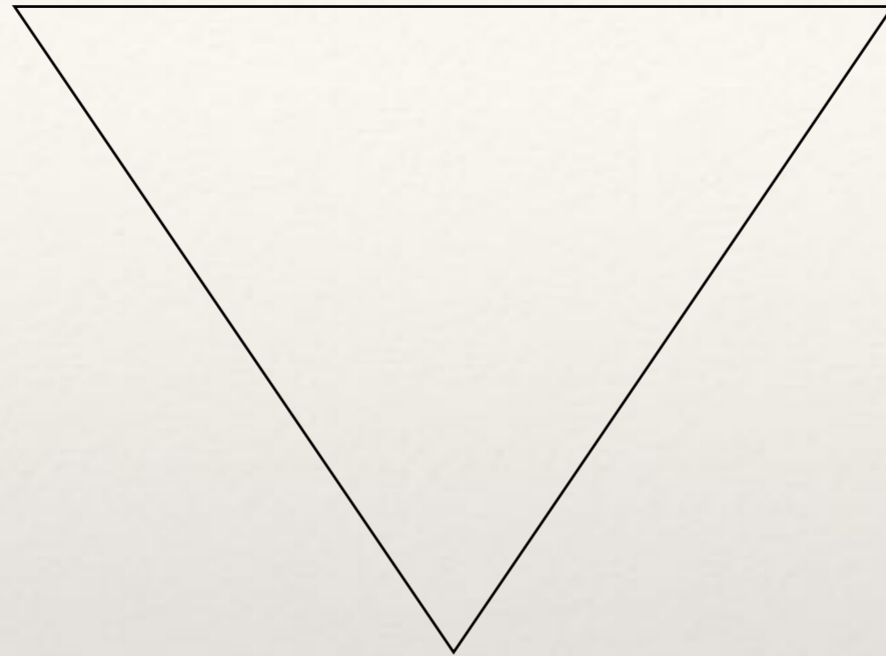

Alvaro García Peón

Aart Strootman



Outside of the instrumental possibilities

Shri Camel

Terry Riley





Terry Riley

Shri Camel

Shri Camel

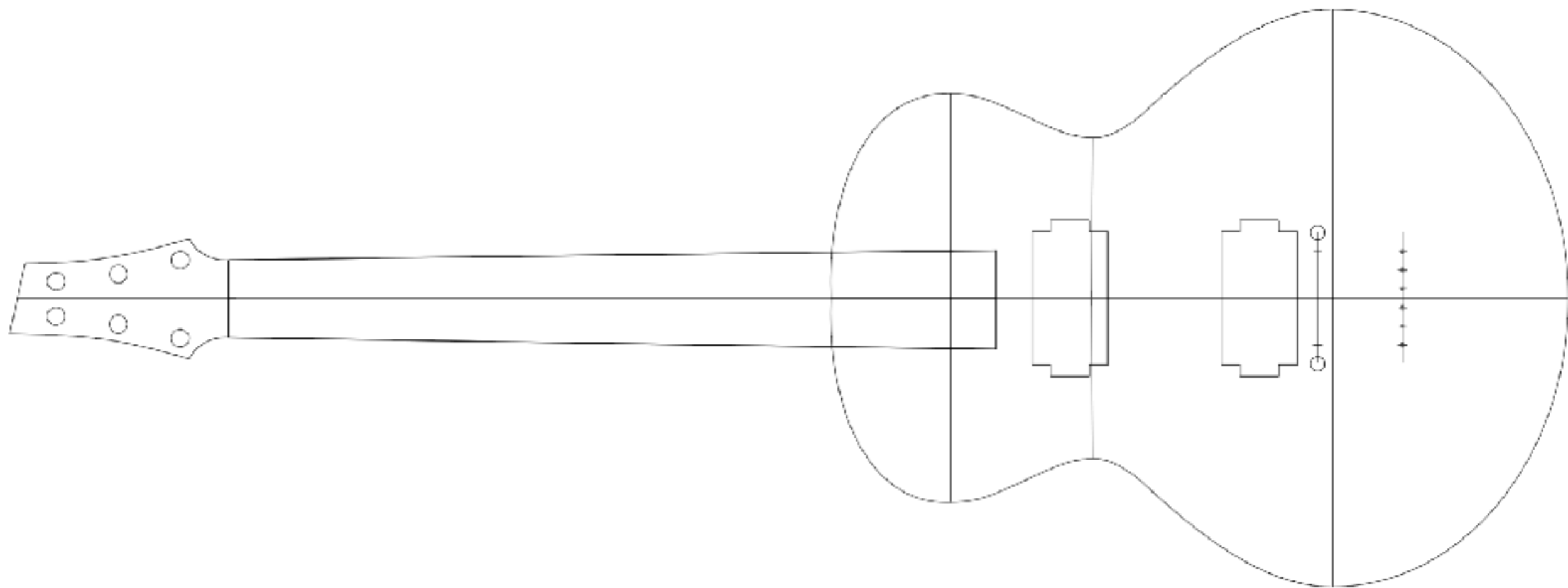

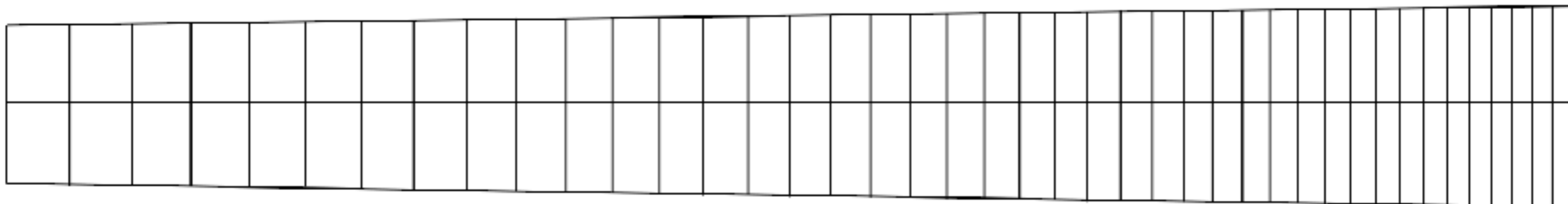
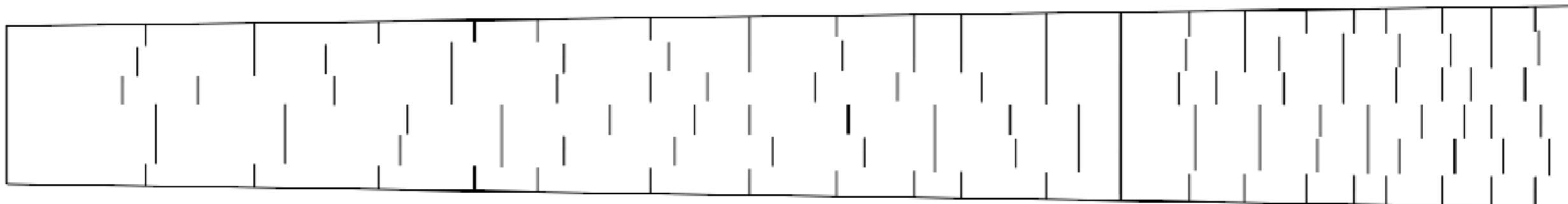
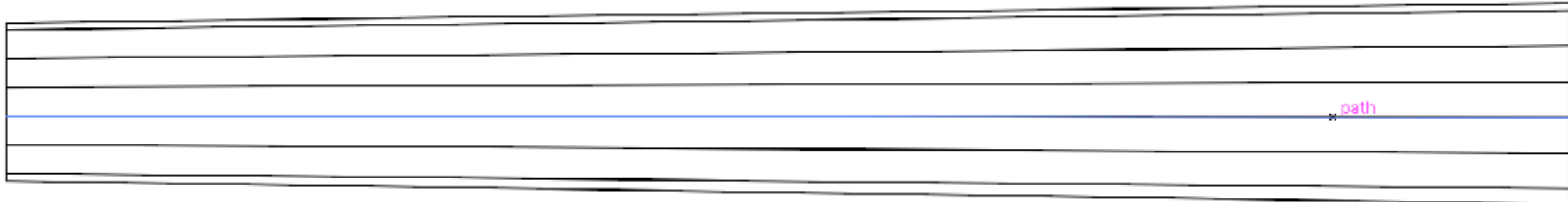





Just intonation - existing repertoire

- ❖ One of the most exotic scales any major piece of music has ever been based on is that of La Monte Young's *The Well-Tuned Piano*, given here:

Notes:	E \flat	E	F	F \sharp	G	G \sharp	A	B \flat	B	C	C \sharp	D
Ratios:	1/1	567/512	9/8	147/128	21/16	1323/1024	189/128	3/2	49/32	7/4	441/256	63/32
Cents:	0	177	204	240	471	444	675	702	738	969	942	1173

- ❖ Or Ben Johnston's *Suite for Microtonal Piano*

Notes:	C	C \sharp	D	E \flat	E	F	F \sharp	G	A \flat	A	B \flat	B
Ratios:	1/1	17/16	9/8	19/16	5/4	21/16	11/8	3/2	13/8	27/16	7/4	15/8
Cents:	0	105	203.9	297.5	386.3	470.8	551.3	702	840.5	905.9	968.8	1088.3

Javascript Fret Position Calculators

Consider that the fundamental pitch of a vibrating perfect string goes up an octave if the length of the string is halved. Also consider that there are twelve tones in the equally tempered scale. From this it should be apparent that fret position offset will be a function of the twelfth root of two. The twelfth root of two is the number which, if multiplied by itself twelve times, would equal two. It is approximately 1.0594630943593. The offset from the nut can be calculated for any fret by using the following formula, presented in spreadsheet format and as a Javascript applet:

Calculating Fret Spacing for a Single Fret

$$d = s - (s / (2 ^ (n / 12)))$$

where:

d = distance from nut;

s = scale length;

n = fret number;

1	21,4944012345029	0,631578947368421	1	34,4944012345029	95,1324012345029
2	42,2187869949562	1,26315789473684	2	55,2187869949562	115,856786994956
3	62,2007420172065	1,89473684210526	3	75,2007420172065	135,006742017207
4	81,4568640310365	2,52631578947368	4	94,4668640310365	155,104864031037
5	100,042796160873	3,15789473684211	5	113,042796160873	173,680796160873
6	117,953264059871	3,78947368421053	6	130,953264059871	191,591264059871
7	135,222107320003	4,42105263157895	7	148,222107320003	208,860107320003
8	151,872311503654	5,05263157894737	8	164,872311503654	225,510311503654
9	167,926038738372	5,68421052631579	9	180,926038738372	241,564038738372
10	183,404657215603	6,31578947368421	10	196,404657215603	257,042657215603
11	198,328769632658	6,94736842105263	11	211,328769632658	271,966769632658
12	212,718240615778	7,57894736842105	12	225,718240615778	286,356240615778
13	226,592223160793	8,21052631578947	13	239,592223160793	300,230223160793
14	239,969184126569	8,84210526315789	14	252,969184126569	313,607184126569
15	252,866928815184	9,47368421052632	15	265,866928815184	326,504928815184
16	265,302624671536	10,1052631578947	16	278,302624671536	338,940624671536
17	277,292824133946	10,7368421052632	17	290,292824133946	350,930824133946
18	288,853486666143	11,3684210526316	18	301,853486666143	362,491486666143
19	300	12	19	313	373,638
20	310,747200617251	12,6315789473684	20	323,747200617251	384,385200617251
21	321,109393497477	13,2631578947368	21	334,109393497477	394,747393497477
22	331,100371158644	13,8947368421053	22	344,100371158644	404,738371158644
23	340,733432015519	14,5263157894737	23	353,733432015519	414,371432015519
24	350,021398080437	15,1578947368421	24	363,021398080437	423,659398080437
25	358,976632029935	15,7894736842105	25	371,976632029935	432,614632029935
26	367,811053660001	16,4210526315789	26	380,811053660001	441,249053660001
27	375,936155751828	17,0526315789474	27	388,936155751828	449,574155751828
28	383,963019369186	17,6842105263158	28	396,963019369186	457,601019369186
29	391,702328607801	18,3157894736842	29	404,702328607801	465,340328607801
30	399,164384816329	18,9473684210526	30	412,164384816329	472,802384816329
31	406,35912030789	19,5789473684211	31	419,35912030789	479,99712030789
32	413,296111580397	20,2105263157895	32	426,296111580397	486,934111580397
33	419,984592063285	20,8421052631579	33	432,984592063285	493,622592063285
34	426,433464407592	21,4736842105263	34	439,433464407592	500,071464407592
35	432,851312335768	22,1052631578947	35	445,851312335768	506,289312335768
36	438,846412066973	22,7368421052632	36	451,846412066973	512,284412066973
37	444,426743333071	23,3684210526316	37	457,426743333071	518,064743333071
38	450	24	38	463	523,638

Katherine Teng

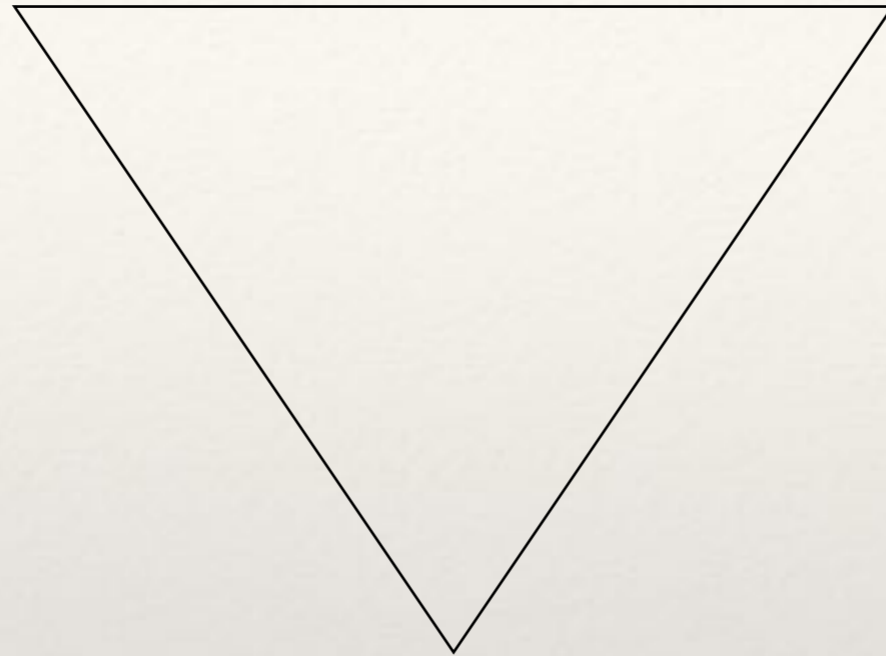

Alvaro García Peón

Aart Strootman



Case study 2:



Creative performer
Performing creative

Musical ideas

Technicality

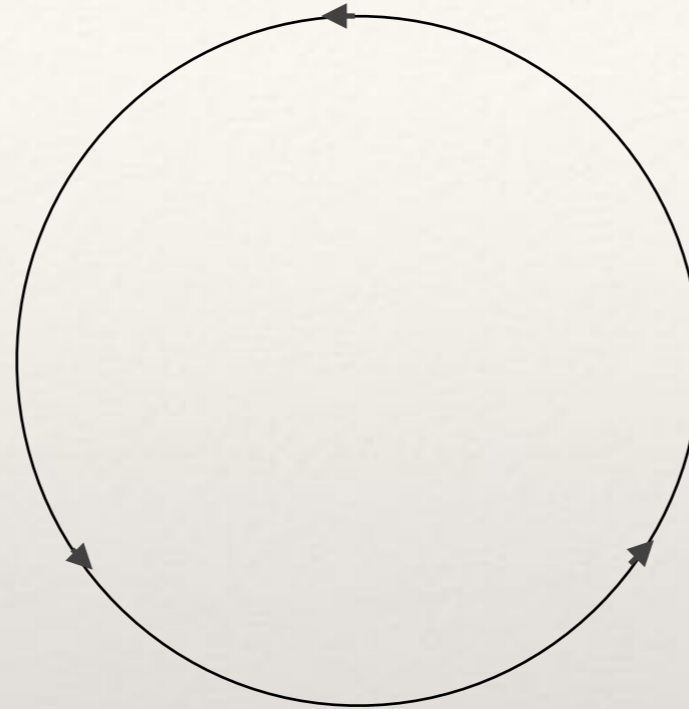

Physical instrument

Creative performer | Performing creative
Aart Strootman and Maria Nabeiro

Musical ideas

Technicality

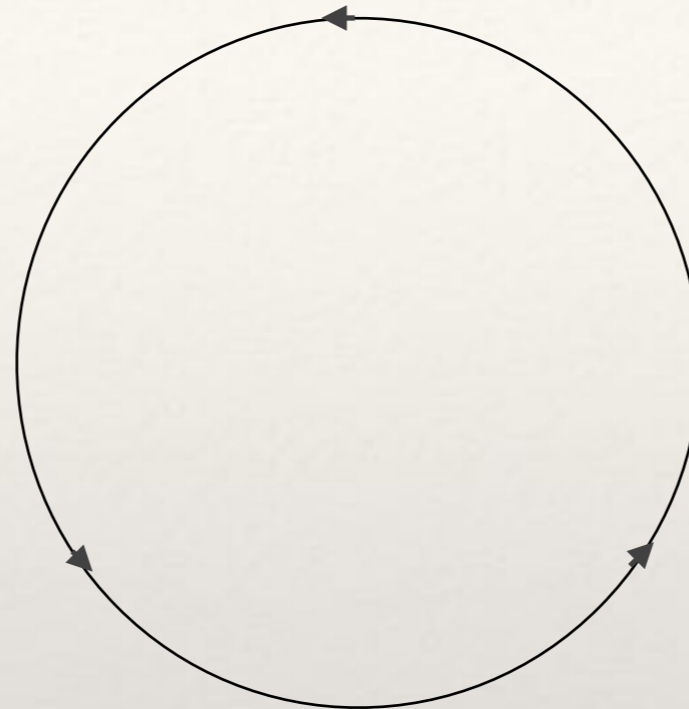

Physical instrument





$$2/1 * 3/2 = 6/2 = 3/2$$
$$2/1 * 2/1 = 4/1 = 2/1$$
$$2/1 * 5/4 = 10/4 = 5/4?$$

Under tone of 3/2

Small *prosthetics*

Small *prosthetics*



Custom fit to instrument of performer

- Material
- Regular setup of the instrument
- String gauge

Small *prosthetics*



Custom fit to instrument of performer

- Material
- Regular setup of the instrument
- String gauge



Might replace the instrument of departure

W.A.L.L

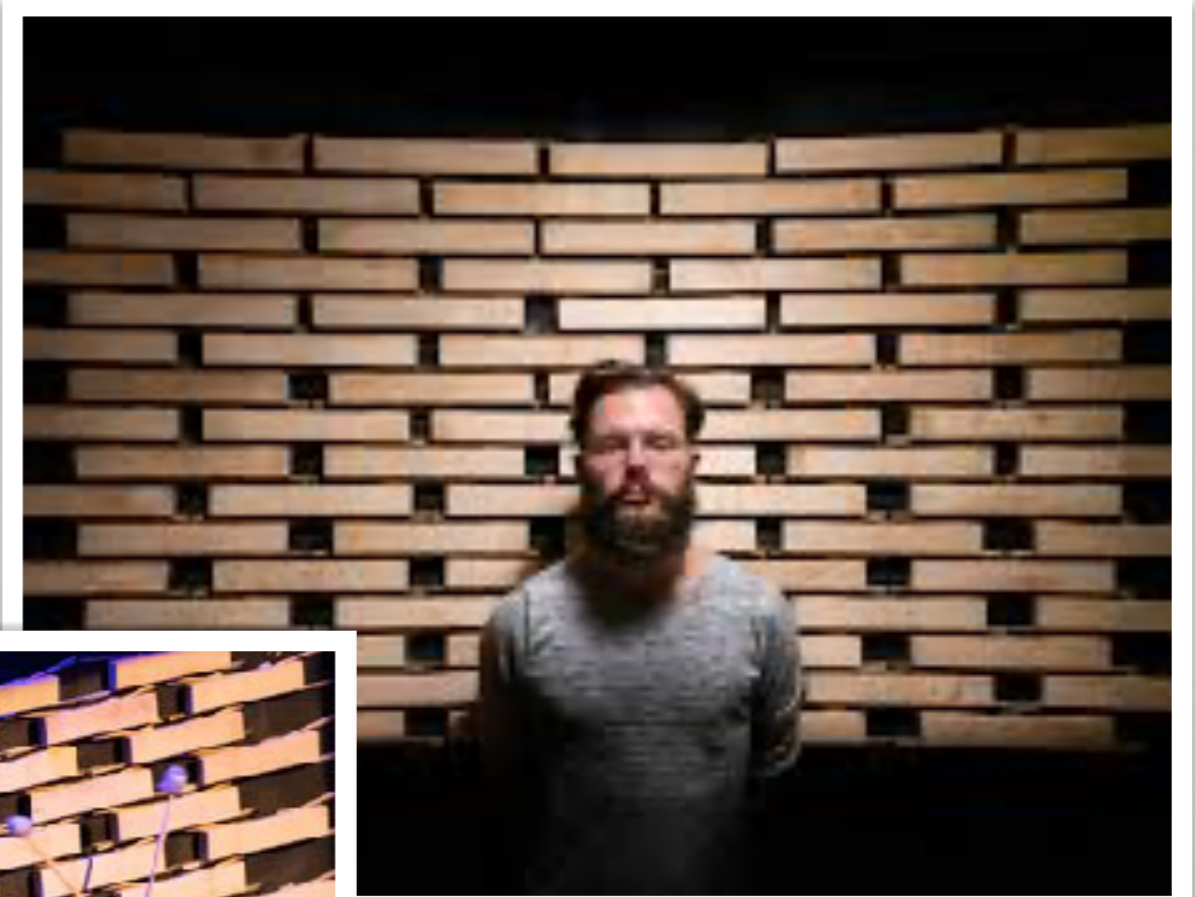

18

Alto marimba high (2-3) (2-3) 1 (2-3) 1 1 3 p

Alto marimba low (4-5) 3 (4-5) (3-4) 1 gliss. 1 gliss. 4 ff pp p

Tenor marimba high 2-3 (2-3) 1 (2-3) 1 (2-3) (1-2) mf

Tenor marimba low 5 gliss. 4 (4-5) 4 4-5 ff pp mp mf

Alto Guitar gliss. gliss. gliss. mf

Electric Guitar capo bottle neck mf

Baritone Guitar 2'50" 3' simile 3'10" 1.v. 3'20" mf

5-string Bass Guitar







Small *prosthetics*



Custom fit to instrument of performer

- Material
- Regular setup of the instrument
- String gauge



Might replace the instrument of departure

Small *prosthetics*



Custom fit to instrument of performer

- Material
- Regular setup of the instrument
- String gauge



Might replace the instrument of departure



Hybrid 2d/3d vector drawing

KonCon

Ensemble Academy

SDH

Asko Schönberg

KonCon
Ensemble Academy
SDH
Asko Schönberg



Ictus	Brussels
Bozzini	Montreal
Sandbox	New York
Riot Ensemble	London
Greywing Ensemble	Melbourne/Perth

KonCon
Ensemble Academy
SDH
Asko Schönberg



Ictus
Bozzini
Sandbox
Riot Ensemble
Greywing Ensemble

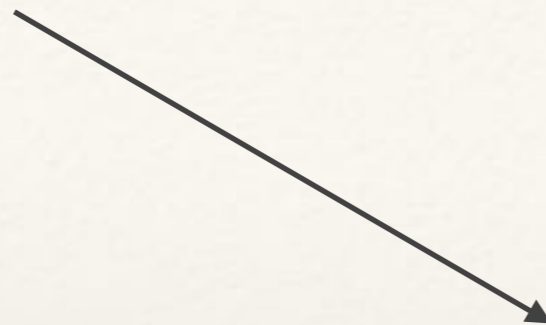

Website
Blog Tim Rutherford-Johnson
Blueprints
'Hub'

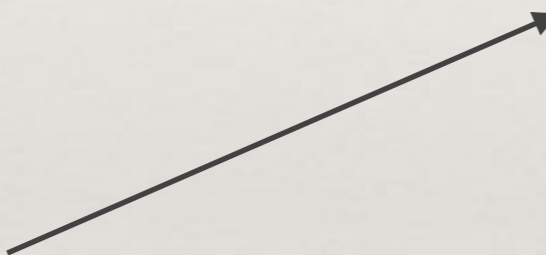

Brussels
Montreal
New York
London
Melbourne/Perth

KonCon
Ensemble Academy
SDH
Asko Schönberg



Ictus
Bozzini
Sandbox
Riot Ensemble
Greywing Ensemble

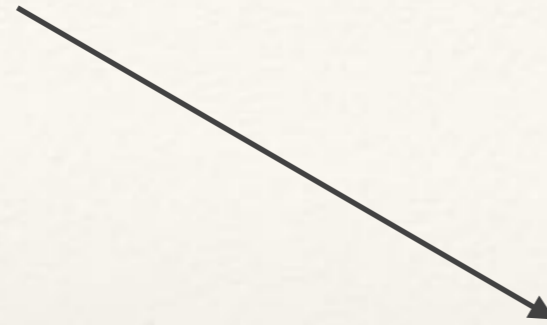

Website
Blog Tim Rutherford-Johnson
Blueprints
'Hub'

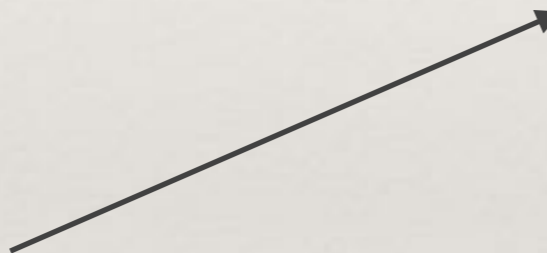

Brussels
Montreal
New York
London
Melbourne/Perth



Composers
Performers
Theorists
Luthiers
Etc.



Aart Strootman Mmus Mmus MA

*Creative performer |
Performing creative*
