

Research report

Karst de Jong

Study: Masters of Music Theory

Royal Conservatoire Den Haag

May 2015

Navigating through Harmony

A spatial and directional concept of the fundamental bass progressions and patterns of the functional modes as a guide to creating logical harmonic progressions in tonal (classical) improvisation.



Table of Contents

Navigating through Harmony

Abstract / 3
An introduction / 5
Research Question / 7
Structure of the Text / 8

The Core Idea

Navigation and Movement / 9
Antecedents of the Directional Approach / 12
The Development of the Arrow System / 16
Summary / 31

Towards A New Approach / 32

The Modulation Project

Description / 43
Lessons Group A / 46
Lessons Group B / 54
Observations and Conclusions / 59

Improvising with an Ensemble

Description / 62
A Workshop in London / 63
Observations / 67

Conclusions / 68

Acknowledgements / 70

References / 71

"I may not have gone where I intended to go, but I think I have ended up where I needed to be."

— Douglas Adams, *The Long Dark Tea-Time of the Soul*

Abstract

The central purpose for this research has been to solve the problems that arise when teaching logical choices of harmonic progressions in tonal improvisation. It is important to acknowledge that specific obstacles must be overcome when harmony is invented in real time while improvising versus when harmony is invented during the composition process. Spatial representation of harmony seems to be a particularly promising place to start when approaching these obstacles and trying to overcome them. Many different graphical representations have been invented for this spatial representation including the musical circle by Johann David Heinichen (Heinichen, 1728) and the regional space by Gottfried Weber (Weber, 1821).

Starting in 2007 through today, I have been undergoing an "ongoing critical dialogue between theory as practice and speculative theory" with mathematical music theorist Thomas Noll. We have been developing new ideas on the role of fundamental progressions and harmony in tonal music. Our inspiration comes from many different sources of music theories as well as a wealth of music literature. Starting from the so-called *simplified Weber space*, we developed a special set of arrow symbols to represent movement within that space. The outcomes of our collaborative efforts are very promising and will serve as input to find answers to the central question of my research.

After reviewing and analyzing the outcomes for their potential use in teaching tonal improvisation (and to a certain extent for teaching music theory in higher music education), a selection of outcomes has been translated into possible, useful concepts to be used as teaching methods. During the main part of the research, these concepts have been tested and compared to existing methods. The testing took place with actual students in actual learning situations and the results have been analyzed, recorded on video, and received commentaries.

Two case studies have been conducted for this research. One involved eight students in the main piano department at the Royal Conservatoire of Den Haag while the other was done with an ensemble of mixed instruments at the Guildhall School of Music and Drama during the Reflective Conservatoire Conference in London (February 2015). The latter has been

prepared with ensembles from my classes on *aural development with the instrument* at the Royal Conservatoire of Den Haag.

As a final conclusion, I hope to establish what makes this research unique and what can potentially contribute to the discourse and contents of what we teach our students. Some ideas for future directions will be formulated. Possible implications for students at higher educational institutions for music include a change in our approach of how we teach tonal improvisation and a better understanding of the inner workings of tonality through practical confrontation with harmony.

An introduction and a brief history of events leading up to this research

The origins and purpose for this research date back to 2006 when I started to seriously consider new strategies on how to teach tonal improvisation. Having used standard concepts and tools for many years while teaching written harmony, composition and harmonic analysis, I could not help but feel these specific concepts were not always appropriate for teaching spontaneous harmonic invention in improvisation. I found myself regularly shouting at students, "No! V65," or "No! V2 should be followed by I6!," or something similar.

Students would then stop playing and start calculating. "Mmm, what's a V65 in Eb major again? Let's see...Bb, D... Ahhhhh, oh no, wrong bass note, etc." There is simply not enough time for a person to think while solving a written harmony or composition exercise while improvising. During the improvisation process, the mind works in a completely different way. Calculation clearly stands in the way of continuity, flow and listening.

One day, it finally occurred to me that we often speak about direction in music: ascending or descending melody lines or bass lines, sequences of falling fifths, monte sequences, upper and lower neighboring notes, etc. Wouldn't it be a good idea to define harmonic movement as having a direction? Couldn't we find a way to describe that direction more precisely?

One observation which helped me is that harmony and particularly a bass line does not behave in the same way as melody. Instead of observing stepwise motion, looking at fifth progressions provides more results since they form the basis of the harmonic organization in our Western tonal music. So I started to experiment with circles of fifths, moving up and down, and also manipulating the position of the tritone in order to create logical connections between keys. I tried to stop making the students think of a specific key. Instead, I wanted them to move in "logical" ways over the keyboard, being conscious of the harmonies they played in relationship to the corresponding diatonic cycle of fifths.

A starting point for the work was the separation of a tone dimension, where the elementary intervals are not steps (i.e. major and minor seconds) but fifths and fourths. Although I find it still most convenient to use the metaphor of an up and down motion also for fifths, it is useful to allocate ones awareness about these motions in a space which is not identical with the space of stepwise melodic ascent or descent. The initial separation of the two kinds of measurement induced the desire to understand their interaction as well.

When I first met the German mathematician and music theorist Thomas Noll in the year 2006-2007 during a meeting with the theory and composition department at the ESMUC in Barcelona, he had just been appointed to teach the subject *Theory and Composition Techniques of the 20th Century* at this school. Noll was investigating some ideas regarding the connection of scale theory and harmony. His work coincided in interesting ways with the circle of fifths experiments I was carrying out with my improvisation students. Since this meeting, both of us have been engaged in an ongoing critical dialogue about two essential musical ingredients of tonal music: scales and harmony. During the fall of 2006, we brainstormed some concepts and handed in an abstract for the upcoming Dutch Society of Music Theory conference in February 2007 since improvisation was the main topic at this particular conference. The resulting presentation led to our first collaboration together in the form of a published article in the DJMT Journal (Noll, Thomas and Karst de Jong, 2008).

Content in subsequent chapters found in this report include our collaborative research work. I have also included some external sources and pedagogical considerations involving a case study with pianists and a workshop with an ensemble in London. It is my hope that I can bring together theoretical reflection, musical practice and an educational strategy to contribute to the important discourse on the role of improvisation at higher music educational institutions as well as the development of the class syllabus and lessons. In my opinion, this dialogue between research and practice is the core element in relevant artistic research.

Research Question

The central topic of this research is the implementation of acquired theoretical ideas and concepts about harmony into the teaching of tonal improvisation. Among these concepts, the following are the most important:

- The Simplified Weber grid as a way to navigate through harmonic space
- Arrow symbols (directional symbols) as a representation of underlying fundamental progressions
- The Tetractys scale and functional modes as a way of connecting the above to classical Tonality

The central question would then be:

How can spatial representation of harmony contribute to the understanding and teaching of harmonic progressions in tonal improvisation? And does the application of the directional approach provide an effective navigation tool for the improviser while shaping the harmony?

Structure of the Text

In the chapter *The Core Idea* I review external sources on the spatial representation of harmony, as well as my own previous research activities on the subject, with the intention of using those sources as an input for the teaching projects. *A New Approach* proposes ways of implementing the ideas that have been distilled from *The Core Idea* into my teaching practice. However this chapter is not a minute recipe for lessons, it rather offers general ingredients that can be used in various pedagogical settings. *The modulation project* and *Working with an ensemble* are reports of teaching projects which have been executed with the reflections of the previous chapters in mind. They have taken on their own shape and are separately reflected on in the conclusions. Finally I try to formulate answers to my research questions in the *Conclusions*.

The Core Idea

Navigation and Movement

An observation lies at the core that harmony is both an important motor and a guiding principle in tonal music. The greater tonal plan of a musical composition, or an improvisation for that matter, is comparable to a journey that begins and ends in the same place. However, it finds points of contrasts in other key regions in between that are more or less related. The realization of this harmonic path is not simply a matter of connecting different key regions. It is comprised of a carefully selected succession of chords that have a dialogue with upper structures such as melody, counterpoint and voice leading phenomena. If someone takes the challenge as an improviser to invent this harmonic path spontaneously, this person needs a sense of direction while playing. The more general this sense is, the more useful it will be since there will be more room for last moment decisions and details of this realization on the musical surface. As I mentioned in my introduction, I have been looking for a guiding principle that could somehow show the way without being too specific and believe that this principle can be found in the fundamental bass. More specifically, this may be found in the melody and patterns of the underlying fundamentals of the harmony. By studying these underlying fundamentals and actively manipulating them, the improviser can learn how to *navigate* and literally control the direction of the improvisation, with one's eye (ear) on the compass.

From a practical standpoint, this means the musician must start paying attention to the different layers in music and tune in to this fundamental layer which is responsible for the direction of the harmony. This person needs to distinguish the surface rhythm from the harmonic rhythm and the deeper fundamental layer underneath. These different structural layers work together and are comparable to a clock with gears of varying dimensions, all connected to create a synchronous reading of hours, minutes, seconds and the date. A musical example from Bach's St. John's passion may serve to illustrate this concept:

<http://www.strongspace.com/shared/8dnlookm74>

[AUDIO] J.S. Bach, *St. Johns Passion*: excerpt from the opening choir:

CORO.

The musical score is arranged in a standard orchestral format. From top to bottom, the staves are: Flauto traverso I. (Oboe I.), Flauto traverso II. (Oboe II.), Violino I., Violino II., Viola, Soprano, Alto, Tenore, Basso, and Organo e Continuo. The organ and violins play a continuous, pulsating bass line. The oboes play a counterpoint of two melodies. The choir parts are mostly silent in the first few measures.

J.S. Bach, *St. Johns Passion*, first measures of the opening choir

This beginning of the opening choir is composed in various layers. The slowest moving layer is the fundament, a pulsating pedal on the tonic initially that stands for 9 bars (32 seconds!) before moving to the dominant. It then slowly speeds up in a diatonic circle towards the end of the phrase. When they are superimposed, we find a faster harmonic layer, moving roughly two chords per measure. Floating over it, the oboes play a counterpoint of two melodies in the higher registers; a haunting dialogue of dissonances and resolutions in long, screeching notes. To create a sense of motion together with the pulse in the deepest bass, Bach added the embellishment of the middle harmonic layer in sixteenth notes of parallel thirds and sixths, both confirming and questioning the chords. When hearing such a masterpiece, one realizes what exceptional power music can have to evoke emotions, and its ability to create an experience of space and time for the listener.

This leads to the second important point. Music is motion, and this is extremely important when teaching improvisation. It allows us to discuss all aspects of this motion: speed, direction and space. We know these aspects are ultimately mere metaphors, and that we cannot directly compare them to the same aspects in the physical world. Nevertheless, they give us important idea that we can work with. Further inspiration can be found in so called

Neo-Riemannian theories, which stress the relationships between tones and chords that have traditionally been described as static. In the words of Victor Zuckerkandl: "Tones are elements of a musical context because and in so far as they are conveyors of a motion that goes through them and beyond them. When we hear music, what we hear above all is motions." (Zuckerkandl, 1956).

Another realization I have made is that this movement of one chord into another can be regarded as a musical act. Instead of describing the quality of the individual chords themselves, I have been looking for a way to describe these acts together. We came up with a series of symbols to annotate these acts, which in turn became the arrow language, as described in the following chapter. Many theoretical speculations that have surfaced over the past few years have flowed from this original idea.

Antecedents of the Directional Approach

In this chapter, I'd like to discuss briefly three sources which are related to the ideas of spatial representation of harmony, alternative annotation methods for harmony, and harmonic analysis based on fundament progressions. I have absolutely no intention to be complete in quoting all other possible sources. Instead, I tried to make a selection that provides both connections to the previous chapter as well as giving a wider point of view which can possibly be incorporated in pedagogical approaches.

Jamie L. Henke, *An Historical Survey of the Origins of the Circle*

In her very interesting article *An Historical Survey of the Origins of the Circle* (Henke 1997), Jamie L. Henke is looking for the origins of the dominant-tonic progression, the development of the V-I cadential formula and the reasons behind the subsequent hegemony of the falling fifth progression. Reasons she mentions are the development of the perfect fourth as a dissonance during the fifteenth century and the increasing number of voices in the polyphonic texture, making a jumping voice necessary. Circles of fifths start occurring from Jacob Obrecht onwards, who apparently was the first to extend the cadential formula from dominant-tonic to supertonic-dominant-tonic. Early examples of circles occur also in Gabrieli and Schütz, where interestingly enough the tritone is avoided or simply skipped (this strengthens the argument that a tritone is fundamentally different from a perfect fifth. A shift instead of a progression). Further on Henke mentions the first graphical representations of circles by Johann David Heinichen (Heinichen 1728) and Johann Mattheson (Mattheson 1731):



Heinichen's circle

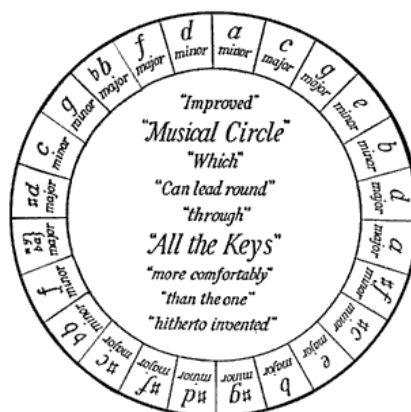

Mattheson's "improved" circle

It is fascinating to note that the order of keys in Heinichen's circle is exactly the one that Chopin used more than a century later for his Preludes op.28. According to Heinichen, the musical circle is useful in composition, accompanying from unfigured bass and playing preludes on keyed instruments. The latter is a clear, early manifestation of improvisation guided by graphical and spatial representation. Mattheson's called his version of the circle *improved*. It omits the major second relations in favor of the minor thirds for more "comfort," thus acknowledging the closeness of the minor third. This also complies with Rameau when he describes the ascending major second relationship as a "*double emploi*:" the result of a descending minor third and falling perfect fifth. The article in the end acknowledges Simon Sechter's writings: "He (Sechter) is the only theorist who appears to have discussed the circle series based upon its actual behavior in musical literature... Sechter treats the circle series, not as an abstract theoretical entity, but rather as a valid theoretical construct with specific, varied functions in music." Sechter, in my opinion, is therefore an important source in further theoretical research in this matter.

As a way to conclude, I would like to include one more quote from the article, which relates to the case study on modulation that I will describe later on. I cite: "Kirnberger states that modulation should result only in movement to closely related keys, and that each of these keys should encompass at least one to two measures. This poses several interesting questions. If modulation through these keys is supposed to occur over one to two measure spans, one key at a time, how is this reconciled with the music of J. S. Bach in which one can find many instances of full circle series occurring twice over the span of two measures? Is it possible that the term "key" has a different meaning in this particular context? Or is it possible that at this point in history only the linear aspects of the circle series were noted, and thus the harmonic elements of the circle series were not considered as modulatory key relations?" We may have to shift the discourse of the verbal to the non-verbal here. It is an almost philosophical question to which active experimenting by playing may provide a more interesting answer than further research and discussion of sources.

Ian Quinn, Harmonic function without primary triads

Ian Quinn's paper *Harmonic function without primary triads* (Quinn, 2005) which he presented at the SMT Conference in Cambridge in 2005 has not been published officially but can be found online. In this paper, Quinn describes an approach to tonal harmonic function

that deviates from the traditional Riemannian approach. Harmonic function can in fact be applied independently of single primary triads or chord roots. The concept of his approach involves treating chords as collections of scale degrees. The paper is interesting for a number of reasons. First, it attempts to formulate an expanded view on harmonic functions. Secondly, it also explicitly discusses new strategies for the teaching of harmony, where Roman numerals are replaced with simpler symbols. Even though improvisation is not mentioned as such, the paper has a few parallel goals in common with my own. As Quinn states about replacing the Roman numerals with a simpler system: "I want students to spend less time working out abstract exercises in the second and third semester of our sequence, and more time behaving like composers and analysts, dealing with real musical surfaces, and real musical situations..... It's my experience that students need all the help they can get in focusing on bass lines and harmonic function, and that Roman numerals encourage them to get lost in other details." For improvisation, this would be even truer. There is no time for complex calculations during the process of playing and Roman numerals stop the natural flow of musical thought.

Quinn provides another nice example to illustrate his point. He asks the audience to consider two strings of Roman numerals:

I—VII_{6/5}—I₆—IV₇—I_{6/4}—V

I—V_{6/4}—I₆—II_{6/5}—V₇—I

He observed the reactions of students when asked to compare the two, and he remarks: "who can blame a student for inferring that, for example, the VII_{6/5} in the first example has more in common with the II_{6/5} chord in the second than it does with the V_{6/4} -- both are, after all, seventh chords in first inversion." His own system should come to the rescue here, where he only indicates for each chord its tonal function (T, S or D) followed by the number of the bass note in the scale of the current tonality. He calls them *functional-bass symbols*.

The following picture shows a comparison of the Roman numerals, Quinn's *functional-bass symbols* and the *arrow symbols* with *functional modes*:

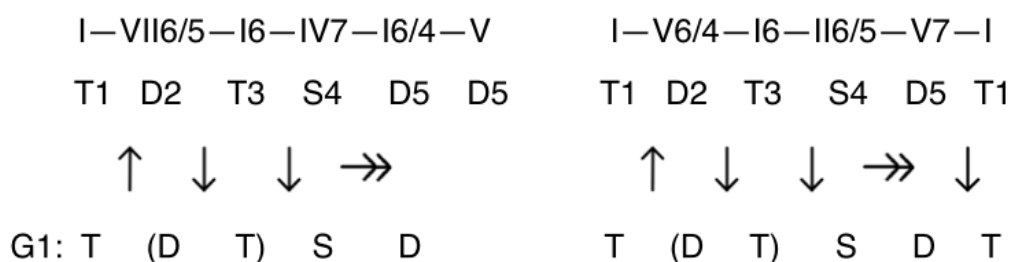

The amount of information actually becomes less from top to bottom, or *less specific*. Quinn comments on his annotation: "The lack of specificity is, to my mind, a virtue. It encourages students to form categories that fit naturally with prevailing views of tonal syntax." In his practice, he is working with students mainly on analysis and stylistic composition. For improvisation, less specificity may be even better. However, it means also more responsibility for the creator (i.e. the student). The musical content is almost completely in the hand of the improviser, and the guiding principle, the nature of the *changes* and the *act* of the harmonic progressions are experienced as paths leading the narrative of the music.

Zsolt Gárdonyi, *Harmonik*

Gárdonyi's book *Harmonik* (Gárdonyi 1990) is one of the few modern harmony books that use fundament progressions as a starting point for the writing and analysis of harmony. It is meant to be used as an educational textbook to be used in the classroom at higher educational institutions where students study music. The first chapter of the book divides all harmonic progressions in two main groups: *authentic* and *plagal progressions*. By doing so, Gárdonyi places himself firmly in the tradition of Rameau and Schoenberg. All progressions based on a falling fifth, including the diminished fifth are called *main authentic progressions* (AH, authentischer Hauptschritt). Consequently, all progressions based on a rising fifth, including the diminished fifth, are called *main plagal progressions* (PH, plagaler Hauptschritt). All other progressions are summarized as follows: authentic are all fundament progressions of falling thirds, fifths and sevenths and their complementary ascending intervals. Plagal are all ascending thirds, fifths and sevenths and their complementary descending intervals. He also describes the authentic and plagal *pendulum*, which correspond to our concepts of *up-down* prolongation and *down-up* prolongation.

The Development of the Arrow System

Review and Analysis

The sources reviewed in this chapter are derived from the research into the structural role of fundamentals in tonal music, as conducted in collaboration with Thomas Noll over the past few years. Central has been the premise of the fundament melody as a guiding and autonomous principle. It provides challenging tasks for continued dialogue with my wonderful colleagues from all over the world. One of the highlights for me was our recent contribution to the session on tonality at the EuroMac conference in Leuven. We will present a small paper again at the SMT conference in St. Louis in October 2015. Regarding the subject of tonal improvisation, I considered the relevant work between 2007 and 2011 as input for the pedagogical considerations and experiments which will be described in the later chapters (the newer research work needs more digesting and feedback from the community before it can be used in teaching). Most of these sources consist of conference presentations and articles published in international, peer-reviewed journals. In the second chapter on sources, I will briefly discuss some external sources that have inspired my teaching.

The development of idea's since 2007 went roughly as follows:

1. Taking the Simplified Weber space as a model: a spatial representation of chord fundamentals as a starting point, and exploring free (contiguous) movement within this space.
2. Arrow symbols: The development of a set of symbols to represent the direction of the fundamental bass lines, providing a framework for analysis when combined with the contiguity principle.
3. Footprints of tonality: recurring patterns of the 'melody' of the fundamental bass. Structural scales and their modal refinement. A hierarchical view in which footprints are embedded.
4. Functional interpretation of the structural modes. Searching for integration with traditional approaches: Rameau, Sechter, Riemann and Dahlhaus, Schenker and Caplin.

5. Under investigation: The exact relationship between fundamental bass and real bass. Structural bass as a mediating concept. Future plans: how do we connect to upper-structures (chord forms and voice leading).

However, I do not intend to simply reiterate the theoretical argumentations in those sources. Instead, I would rather distill those outcomes and concepts which are potentially useful for the pedagogy of improvisation and comment on them. If there is any need for further clarification, please consult the original sources from the references in the bibliography.

The following sources will be looked at:

- **Presentation at the VVM Conference in Groningen (February 2007) and the article in the proceedings issue of the Dutch Journal of Music Theory (February 2008)**
- **Lecture: The Fundamental Path: Towards an Integration of Theory, Analysis and Teaching of Fundamental Progressions, Koninklijk Conservatorium Den Haag, (June 26, 2007)**
- **Presentation at the EuroMac Conference in Freiburg (October 2007)**
- **Presentation at the VVM Conference in Amsterdam (2010)**
- **Presentation at the MCM Conference in Paris (June 2011) and the Article published in its proceedings**

In February 2007, Thomas Noll and I led a presentation on improvisation at the annual conference of the Dutch Belgian Society of Music Theory in Groningen. Our presentation was the first result of our collaborative efforts to understand more of the inner workings of harmony, titled "De-evilizing the devil: Improvising Substitutions in Contiguous Fundamental Bass Progressions." It was the first step in a "report of an ongoing critical dialogue between theory as practice and speculative theory." The presentation was later summarized in an article for the proceedings issue of the conference and published in February 2008. The title of this article was "Contiguous Fundamental Bass Progressions" (Noll, Thomas and Karst de Jong, 2008).

We looked at various theoretical *anchors* in order to arrive at a new interpretation of tonal space as a network of fundamentals within two main dimensions. These anchors were:

- Rameau's concepts of contiguity and the *double emploi*. (Rameau, 1737)
- Nicolas Meeús' *vecteur harmonique* (Meeús, 2000)
- Norman Carey & David Clampitt's *theory of well-formed scales* (Carey & Clampitt, 1989)
- Gottfried Weber's *regional space* (Weber, 1821)
- Lendvai's *axis system* (Lendvai, 1995)

First Steps

The starting point for both the presentation and the article mentioned above was to represent harmonic movement as a change of the underlying fundament in a certain *direction*. Harmonic progressions can therefore be considered musical acts rather than a mere succession of musical objects. Each act, progression or movement to the next chord can be represented by a directional arrow symbol. The space in which the movements take place is the so-called "Simplified Weber space," an adaptation of Gottfried Weber's regional space (Weber, 1821). Weber's original regional space was a grid of key relationships where uppercase letters indicate major keys and lowercase letters indicate minor keys. The vertical plane connects keys with a perfect fifth relation, while the horizontal plane alternatively connects to the parallel major/minor and the relative major/minor keys on minor third distance. The graph looks like this:

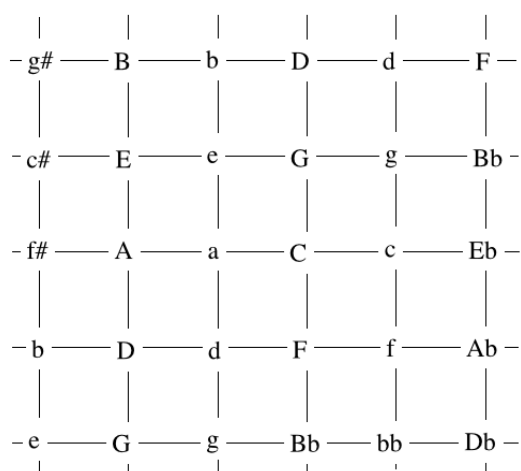

As a starting point, we decided to focus on the role of the fundamental progressions in the harmonic structure. Weber's graph can be collapsed and simplified to understand this role. The upper structures of the chords are ignored, regardless of whether they are triads, seventh chords or any other type of chord. This allows us to investigate purely the underlying fundamental melody as a guide to the harmonic progressions in tonal music. The switch from Weber's original space to the simplified space does not just collapse the major and minor regions. Through the interpretation of the lattice points as fundamentals rather than regions, we also lose the implicit meaning of the minor third as the distance between a major tonic and its relative minor tonic. It is obvious for the perfect fifths, but why should elementary connections between fundamentals be minor thirds? In the beginning, we used the lattice as a heuristic tool, motivated by practical observations. However, we later found a theoretical justification for the minor third as a structural augmented prime (Noll, Thomas and Karst de Jong 2011). For a more detailed argumentation about this choice, I'd like to refer to the original paper (Noll, Thomas and Karst de Jong, 2008). In the new diagram, the nodes stand for fundamentals, allowing any number of chords to form the upper structure of those fundamentals:

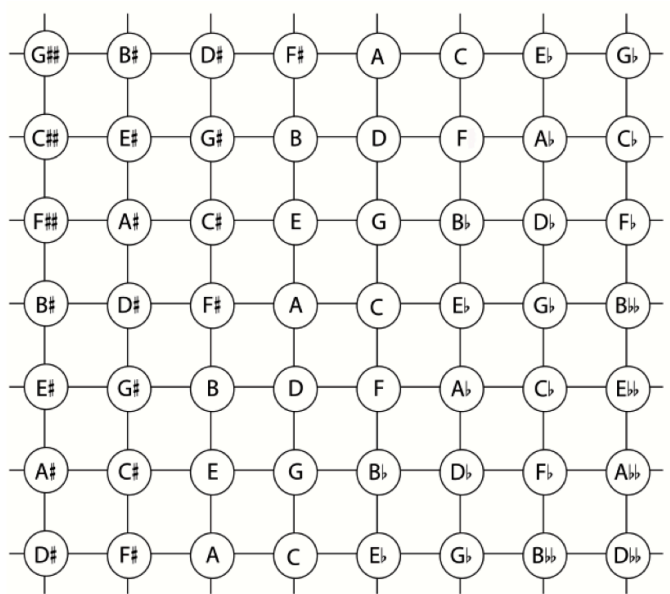



Simplified Weber space

In this space, vertical movement represents movement of the fundamental in perfect fifths (up and down) while horizontal movement represents movement in minor thirds (left and right). Take the common cadential progression I – IV - II6 - I64 - V7 - I as an example. In the key of

C, this would be represented on the grid with a path starting at C. It would then go down to F, left to D, down to G and finally down to C. Although it is found in a different place on the grid, the final C is equal to the beginning C. The title of the article refers to the hypothesis that all harmonic movement in tonal music is inherently contiguous, which means it follows an adjacent path on the grid.





To indicate the directions, we developed a set of arrow symbols to represent every possible movement in the fundamental bass. These are always expressed in perfect fifths and minor thirds, or a compound of the two. First, there are the up and down progressions. They represent all harmonic progressions of which the fundamentals are a perfect fifth apart:

| | |
|---|---|
|  fifth down (or fourth up) |  fifth up (or fourth down) |
|---|---|

Authentic direction

Plagal direction









Next, there are sideways substitutions or "shifts." These occur as minor thirds and tritones:

| | |
|---|---|
|  single minor third down |  single minor third up |
|  diminished fifth down |  diminished fifth up |

Shifts

The diminished fifth or tritone is equivalent to a double minor third or two steps in the grid. (Notice the shift of three minor thirds, or the diminished 7th is enharmonically equivalent to the minor third shift in the other direction).

Besides these direct movements there are the compound progressions that consist of a combination of a shift and a vertical progression. They can be divided in compound dominant (authentic) and compound subdominant (plagal) progressions as follows:

| | |
|---|---|
|  M2 up |  M2 down |
|  M3 down |  M3 up |
|  m2 down |  m2 up |
|  A1 down |  A1 up |

Compound authentic Compound plagal

The distinction can be made theoretically between causal and final progressions (falling fifth before or after the shift), but this often has no practical meaning. In fact, it may even be preferable to invent a single symbol instead of the compound one in order to stress the resulting fundament progression as an act in itself. This can be illustrated with the quite commonly occurring compound progression of the ascending major second (such as what happens between I and II or IV and V). On the left the original compound symbol, in the middle the diagonal version, and to the right the so called "fast-right", alluding to Schoenberg's equivalent *strong progression* (Schoenberg,1954)



Left-down is thus equivalent to the diagonal arrow and the fast-right arrow. Rameau has famously argued that this type of progression is in fact a result of an implied fundament, which causes a falling fifth progression to occur. IV-V therefore becomes an implied II-V progression, the so-called *double emploi* (Rameau, 1722). The same movement is possible between I-II and V-VI.

All possible fundament progressions can therefore be expressed either as a single or compound movement of these directions:

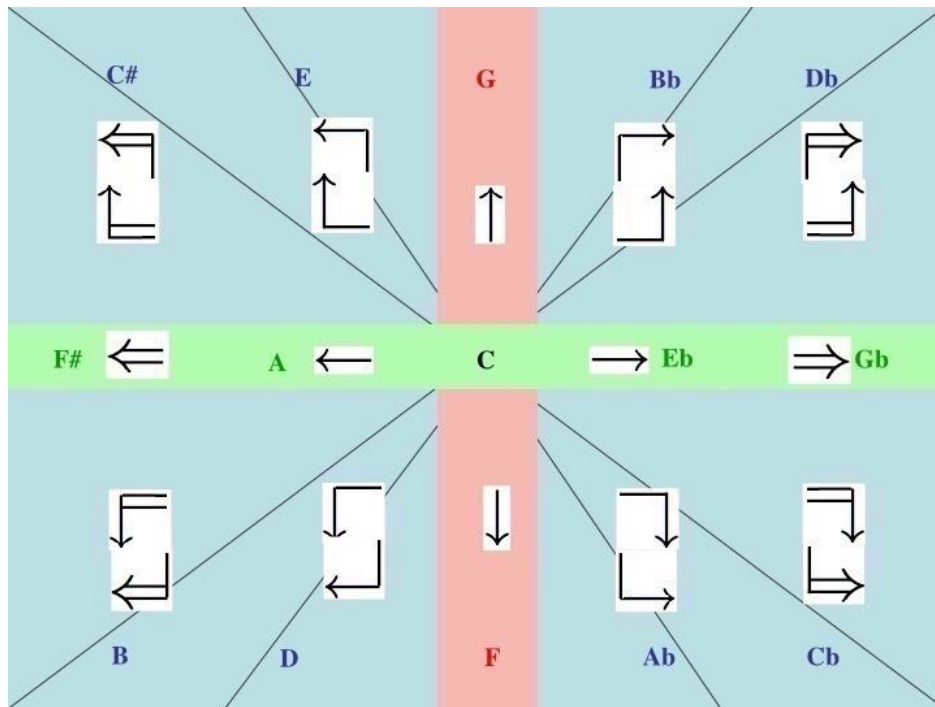

All possible fundament progressions

Already in 2007 we stated that this interpretation should ultimately lead to practical and pedagogical applications, notably in tonal improvisation, but also in analysis, teaching of harmony, aural training and other disciplines.

The article then discusses further theoretical anchors such as Nicolas Meeùs' *Vecteur Harmonique* and Lendvai's *Axial System*.

The second part of the article is about practical applications in analysis and improvisation. First, the diatonic circle of fifths is discussed. In arrow notation, it looks like the following:

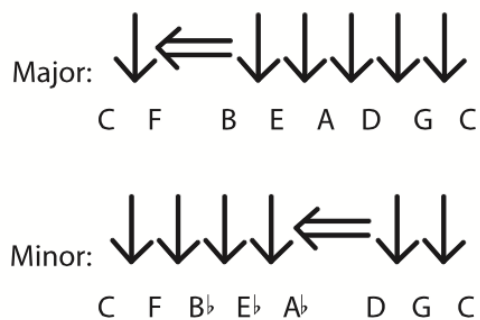

Diatonic circles in major and minor

The role of the tritone can be understood as a necessary shift to stay within one diatonic scale. While from a generic diatonic perspective the diminished fifth is treated as a fifth, and consequently (implicitly) as a progression (with all the complications in functional harmony about functional different and indifferent degrees), the diminished fifth is regarded as a substitution according to our theory as well as common jazz theory. The half steps in the diatonic scale are the result of the combination of a tritone shift and a perfect falling fifth while the whole steps are the result of two falling fifths. A further interesting observation can be made when looking at the turnaround pattern, or the "footprint" as we call it in the article:



Two footprints

This is actually a shortened or half diatonic circle. The single minor third is compensated by three falling fifths, where the tritone (double minor third) in the diatonic circle is compensated by six falling fifths. This minor third therefore earns the nickname "the little devil." It has a shortened pattern with left-down, permutations, harmonization and elaboration with a variety of chord forms in mini-improvisations. It also embeds footprint patterns, includes prolongational patterns (up-down) and introduces the right and up progressions as a contrast.

After discussing some analytical examples from both classical and jazz repertoire, the article continues with abstract patterns on the grid. Paths on the grid can be used as a starting point for an improvisation. The paths have names such as *the square*, *monte sequence*, *giant steps* and the *castle wall*:

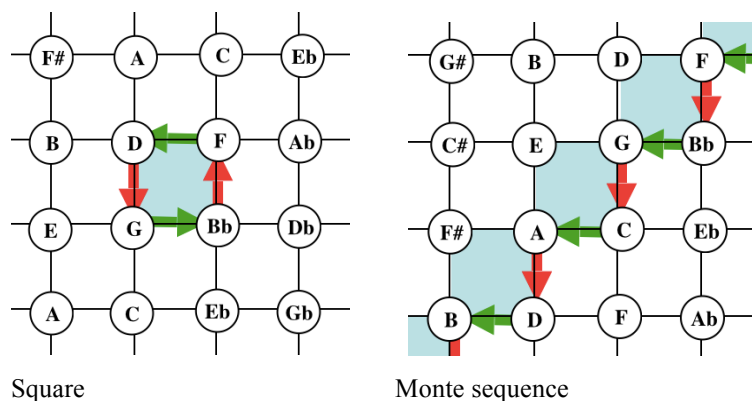

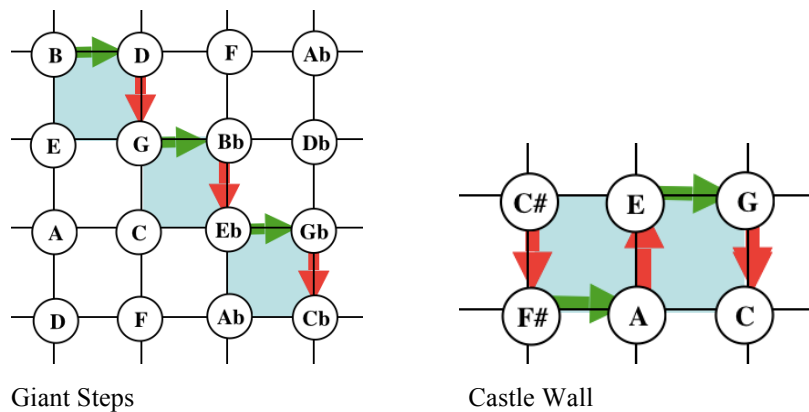

Giant Steps

Castle Wall

The Fundamental Path

During the lecture we gave for our colleagues at the Royal Conservatoire of Den Haag in June 2007, we presented most of the materials from the previous conference in Groningen to begin a discussion both on music theory as well as various aspects of teaching. Examples of different analyses (i.e. *Forlane* from *le Tombeau de Couperin* by Ravel) accompanied the materials. Citing from the abstract:

"This presentation is the result of an ongoing discussion between two colleagues in the theory department at the ESMUC (Escola Superior de Música de Catalunya) in Barcelona: Karst de Jong and Thomas Noll. Both of them are involved with music theory and its applications in very different areas. De Jong handles analysis and teaching of improvisation while Noll is concerned with the relationship between mathematics and music. New theoretical insights have led to a series of analytical experiments and improvisation exercises, which in turn may yield new theoretical implications. The fundamental bass is a dazzling theoretical concept embedded into an ongoing controversy about the interaction of harmony and voice leading. On the one hand, it does not seem safe to solely rely on this concept in pedagogy. However, it has enough allure to make us not simply ignore it. There are two theoretical aspects involved: (1) the determination of possible chords that exemplify a given fundamental and vice versa and (2) the study of fundamental bass progressions. Our approach to this subject is anchored or inspired by ideas from Rameau, Weber, Lendvai, Meeùs, Carey and Clampitt and others. We propose a new interpretation of the Weber Space, which on the one hand yields the theoretical distinction between basic perfect fifth progressions and minor third substitutions (and compound progressions of the two). On the other hand, we yield a didactically powerful visual representation of these progressions."

This presentation primarily added some analyses of the repertoire to the materials presented in Groningen. One analysis presented was of Ravel's *Forlane* from *le Tombeau de Couperin*. What struck here was the high contrast between relatively simple fundamental progressions and a highly complex upper structure of chords and contrapuntal lines, such as what can be observed in the first 4 measures of the piece:



Ravel, beginning of *Forlane* from *le Tombeau de Couperin*

The fundamentals follow the footprint pattern of E and the upper structure challenges this simple underlying fundamental line. This strengthens the idea that simple underlying fundamental patterns can be a general guideline for the construction of tonal music with great stylistic variety, and therefore can be used as navigational tools in improvisations with a seemingly endless varied outcome.

Footprints

The presentation in the EuroMac conference in Freiburg (October 2007) was titled "Footprints in Fundamental Bass Progressions." It was our first attempt to place the previous ideas into a larger framework. We aimed to interpret elements of scale theory in the context of fundamental bass analysis. Recent research by Thomas Noll, Manuel Dominguez and David Clampitt (Noll, Clampitt, Dominguez 2007) provided the input for a speculative theory of "Footprints." We argued that the substitutive role of the minor third (shift) in fundamental progressions is dual to the role of octave substitution in modality (and that this role of the minor third is again comparable to the role of the augmented prime on the diatonic level). The presentation consisted partly of an explanation of the mathematical research which had led to this particular model, and partly of a discussion on the possibilities to use the footprint patterns as an analytical tool to explain the fundamental progressions of tonal compositions on a higher level. A footprint can be described as a 4-note zigzag pattern, separated by perfect

fifths, as shown in the following diagram with the Ionian and Lydian footprints for the notes F \ C / G \ D:

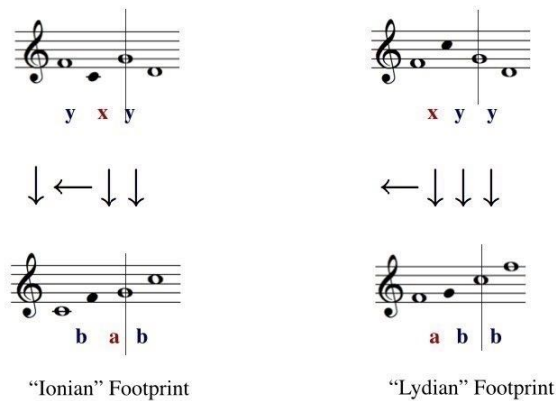

At first this diagram can seem confusing, but it should be read as follows: in the left figure, one starts from C, then a falling fifth down to F, a shift to the left (D) to connect with a falling fifth to G, and a final falling fifth back to C. In the figure on the right, one starts from F, then a shift to the left (D) to connect with a falling fifth to G, followed by two more falling fifths to C and F.

These patterns correspond to two of the footprint permutations as described earlier in this chapter. For the analysis examples used in the presentation, the preludes of Chopin were chosen because of their relative compactness and clear tonal harmonies. We performed a complete analysis of all preludes op.28 in terms of fundament progressions. Here is an example below:

Op. 28, No. 7

Andantino.

Chopin, Prelude op.28 no.7

The very short prelude number 7 is built entirely on a single footprint pattern in the fundamental bass: A - F# - B - E - A. The internal movement of the fundamental melody is annotated by the arrow symbols. We see mostly perfect fifths up and down (tonic to dominant and back), and one minor third shift from A to F# from bar 11 to 12. In the presentations, we showed some more examples taken from the Preludes.

A Modal Approach

The presentation at the annual conference of the Dutch Belgian Society for Music Theory in Amsterdam in October 2010 was titled "Chromaticism and Fundament Progressions: the Tetractys, the Little Devil and Lendvai Amodality." It was a continuation of the earlier research efforts which consider the fundament progressions in tonal music as a virtual melody, which deserves to be described at an autonomous level. We proposed that this virtual melody is more than a mere shadow of the "upper structures" (i.e. chord taxonomy and voice leading) and that it can be studied from a modal perspective. We speculated that fundaments may embody harmonic functions as manifestations of tonality. The harmonic function of a fundament (i.e. its harmonic relation to a presupposed tonic) is described in terms of its scalar position within a *functional mode*, where the tonic is in the position of the Finalis.







Before presenting the functional modes, we must look at the hierarchy of scales. In the article *Aspects of Well-Formed Scales* by Norman Carey and David Clampitt (Carey and Clampitt 1989), we find the following hierarchical overview:



Well-formed scales

All scales in this graph are *well-formed*. They have a few unique properties: all are generated by fifths, there is a fixed relationship between fifths and steps and there are not more than 2 different step intervals that make up the scale. Without going too much into detail, taking a closer look at the graph is very interesting. It brings back to mind the Bach example from the opening choir of St. John Passion. The structural levels we experience in music seem to be represented here in a simple way. What if the melodies and ornaments are actually functioning on the diatonic and chromatic level, while the harmony and fundamentals reside on a lower level? Doesn't it seem fascinating that we could describe the harmonic layer literally on a different scale?

From the moment we thought about this concept, we started looking seriously into the Tetractys scale as a prospect for the structural level of the fundamental bass. The scale has three notes which coincidentally correspond to Riemann's harmonic functions. With three notes, it also has three modes:

| 1st mode | 2nd mode | 3rd mode |
|--|--|---|
|  <p>T S D (T)</p> |  <p>T S D (T)</p> |  <p>T S D (T)</p> |
|  <p>T #S S D #T (T)</p> |  <p>T S #D D #T (T)</p> |  <p>T #S S #D D (T)</p> |

Functional modes (first version)

Just like the notes in the diatonic scales can be altered on the chromatic level (through sharps and flats), the notes of the Tetractys scales can be altered on the pentatonic level. Analogous to the chromatic completions of the diatonic modes, we may regard pentatonic modes as completions of the functional modes. As a consequence, we can consider the chromatic notes (black notes in the graph) as alterations of the main tonal functions. With this reasoning in mind, the idea came about to look at the melody of the fundamentals in a modal way; to assign tonal functions to those fundamentals and to allow alterations of those functions.

Chopin Prelude op.28 no.7 annotated

Based on this modal interpretation, we can now extend our annotation of the score to not only include arrow symbols, but also a designation of the mode (A2) and functional symbols (T, #T etc.). It is important to stress that this annotation is not mathematical, but can actually be experienced in a musical way; harmonic direction is shown by the arrows, and tonal function is more precisely described than in the traditional Riemannian way. Alteration of a tonal function therefore increases its harmonic tension. (Note this type of alteration can be regarded as a theoretical alternative to the Riemannian concept of functional substitution). When we don't distinguish between the modes and allow free alteration of functional fundamentals in all directions, we touch upon the equivalence of harmonic functions at the distance of a minor third. Ernő Lendvai proposed this concept in his book *Symmetrien in der Musik* (Lendvai, 1995). We called this *Lendvai amodality* in the presentation.

Extending this modal interpretation to include all scale degrees of the diatonic did not prove to be an easy task. The following graph shows an interpretation of the full diatonic circle of fifths in the key of g-minor:

Autumn Leaves and the double star

The circle falls apart into the two modes B1 and G1, which are connected by the tritone (*double-left*). This is also how the circle is often experienced musically. One hears B-flat major turning into g-minor. The Diabolo (tritone) is split into two little Devils (minor thirds).

The final part of the presentation was about truncated modes. A truncated mode is a mode which is not finished where one or more progressions are missing at the end:

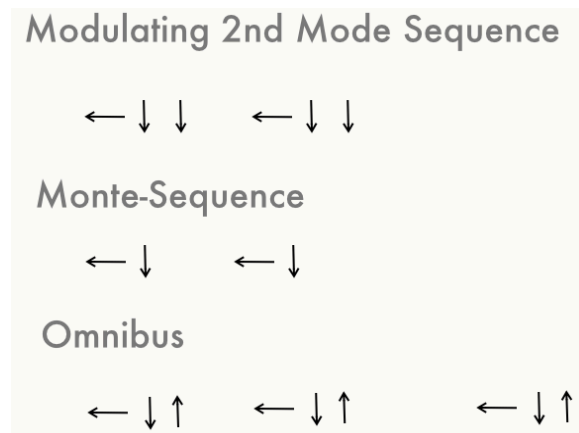

Truncated modes

Leaving out the final falling fifth of the prolongational second mode will cause a modulation to the dominant. Playing this pattern as a sequence will cause modulations fifths upwards. It's a common pattern that occurs in many musical styles. Leaving out another fifth will create the pattern of *left, down* movements. Repeating this movement creates a *Monte sequence*. Finally, the *Omnibus* or *Devils ladder* is a harmonic sequence that became popular in the nineteenth century, especially in the works of Franz Liszt. It is basically a repeating movement to the *left*, filled up with a chromatic bass (prolongational *down, up* pattern).

Refinements

The paper (Noll, Thomas and Karst De Jong 2011) presented at the annual conference of Music and Mathematics in Paris actually expands on the ideas already presented in Amsterdam. The most important contribution is a refinement of the idea of functional modes with analyses to illustrate this concept. Instead of each mode having two chromatic notes (as can be seen in the Amsterdam graph of the functional modes), now we can only consider one of these alterations to be active. A further problematic point is also discussed: how do we decide what the actual fundament of a chord is? There are chords with ambiguous fundamentals or even non-sounding fundamentals. The article ends with a review of truncated modes and sequences. Ultimately, following a single direction in the Simplified Weber space (only vertical or only horizontal) dissolves tonality. The *omnibus* progression and the *chromatic circle of perfect fifths* are examples of this.

The most important conceptual difference with the directional system is the distinction the latter makes between progressive and shift intervals. Only perfect fifths *down* or *up* (*authentic* or *plagal*) are actually considered to be progressive. All other intervals are comparable to a leap in the chain of fifths, enabling a return in either direction. In his lecture in Den Haag (December 15, 2014), Gárdonyi showed the stylistic distinctions between *plagal* versus *authentic* directions of harmony. While the Classical style favors authentic directions, he notes an increasing number of plagal progressions in nineteenth century repertoire. An interesting observation was that sevenths of a chord don't get their stepwise resolution when the harmony moves in a plagal direction. This is interesting for my own research, as I intend to extend the directional system with *guidelines* for voice leading in the future.

Summary

Both internal and external sources discussed are potentially interesting for a wide range of pedagogical activities. They can be used in the teaching of harmony, analysis and aural development. However, for the teaching of improvisation, which is the main subject of this paper, not everything is evidently useful. A lot of mathematical and music theoretical concepts are interesting for the music theoretical discourse, but they are too complicated to have a practical purpose in the improvisation class. On the other hand, some concepts which arise from a complex mathematical background suddenly turn out to be musically very easy to understand, such as the functional modes and the arrow symbols.

Most of the next chapter will be about the translation of useful concepts into pedagogical materials and methods. Later on these pedagogical materials and methods will be tested with students in a real classroom situation, and even at a conference in front of a live audience.

Towards A New Approach

Pedagogical Goals

In today's rapidly changing music world, reviewing and adapting one's teaching practices is inevitable. It is harder than ever to keep the classical music tradition alive in our society, and the role that educational institutions focused on music play is an important one. I believe our craft is currently in danger since we keep educating musicians who are purely performers on the ideas of others (the majority of which is not even with us today). Bringing the creative element back into the music making process as well as our teaching strategy is essential. Improvisation needs to come back on the stage. Our students need to be flexible, highly-skilled *complete* musicians, prepared for a professional future in which they can use their skills to improvise, arrange, compose, interpret and assimilate new musical styles. The new theory curriculum of the Royal Conservatoire is an example of this changing educational practice, where ensemble playing and improvising are integrated into more traditional parts of the curriculum.

There are multiple goals I would like the students to achieve and the most important ones are the following:

- To develop awareness of the various layers in tonal music
- To develop understanding of fundamental structures and underlying key regions
- To become knowledgeable about harmonic structures by understanding which *paths* create tonal stability and which *paths* connect to different key regions
- To develop awareness of the counterpoint created by melodies in relation to the bass (and upper structural elements such as ornamentations and chord colorations)
- To develop active control over the harmonic directions while improvising
- To develop playfulness, creativity and inventiveness
- To make music with your *ear pilot* instead of your *automatic pilot*.

Students in particular who play a monodic instrument are often not aware of what is going on with the bass registers when they listen to music or when they play together. They have not developed an active listening attitude outside the sound of their own instrument. Pianists who we think are harmonically further developed also run the risk of becoming players guided

purely by their motoric skills, and do not use their ears in an active way. It is an enormous pedagogical challenge to find ways to make them experience harmonic progressions as musical acts and distinguish between these different acts. The strategies which have been tested in the ensemble project are important starting points.

Once a person can train their hearing to tune into these harmonic acts, serious attention can be given to shaping an improvisation. I believe that the directional approach of harmony is valuable here because it allows the student to rely on the sensation of harmonic movement rather than on calculations of Roman numerals as an example. There is a general consensus that the verbal part of the brain (giving things names, calculating etc.) interrupts the flow of the improvisation, so the more the awareness and understanding can stretch out to the non-verbal part of the brain, the better off they are to improvise when they play music.

The Meaning of the Harmonic Directions

One of the first questions to answer is: what is exactly the musical meaning of the directions? What is this *act* of going left, right, up or down? As mentioned earlier in this paper, music is movement and harmony is an important aspect that contributes to the sense of this movement. There is also an undisputed circular effect. Tonal music needs the establishment of a center to move away and return to it. Many stylistic elements are at play to make this happen. The falling fifth is the driving force of the harmony in the Baroque and Classical area, but this is much less so in the Romantic and pre-baroque styles. In jazz music, the I - VI - II - V - I turn-around is omnipresent, whereas pop music often seems to favor the "mirrored" version of this turn-around: I - bIII - bVII - IV - I. To say it in terms of Gárdonyi: the classical style favors *authentic* directions while the romantic style contains more and more *plagal* elements (Gárdonyi, 1990).

A related question is: where does harmony stop being *harmonic* and where is it actually more *melodic* in nature? This reaches back to the hierarchical overview of scales as shown in the first sources chapter. As soon as a bass line becomes more melodic (moving toward the chromatic in the graph) and the chords lose strong underlying fundamental fifth progressions to connect them, harmony disappears and becomes linear, melodic motion. This is the case with a *faux bourdon* or *parallel harmony* (the German *Mixtur*). On the other end of the spectrum, we can have pure harmony based on strong functional progressions with all chords

in root position. Of course in most musical structures, we find a continuum between the two extremes: a combination of strong fundamental progressions and linear melodic fillings between some of them. Consider the following example of a path between C and E:



On the left, we see a straight forward way of connecting for example C major with E minor: the tritone connects C as tonic with the second degree of E, followed by a cadence. In the version on the right, the structural harmony between EII and EV is filled in. The black notes can be harmonized by following the rule of the octave of the Partimento tradition. It is one of my main goals to work on a better understanding of real bass versus fundamental bass and the interplay of strictly harmonic and more melodic elements in harmony.

What is the Fundament of a Chord?

First of all students must learn to grasp the meaning of a harmonic fundament. We can practice a few simple paths with alternative chords. Up and down with inversions, dominants, diminished sevenths and so forth. It will then become clear that many realizations are possible for the same fundament progression. A basic way to identify the fundament of a chord is to identify its root by rearranging it into a stack of thirds. However, there are exceptions to this rule, such as the diminished seventh chord where the actual fundament is silent.

1. Regular triads and seventh chords: In these chords, the fundamental bass is the same as the root. The prototypical examples are the root positions and inversions of major and minor triads, and the four types of diatonic seventh chords.
2. Diminished: For the diminished triad and the diminished seventh chord, we identify the fundament as a silent tone, which is a major third below the root.
3. Real Bass: In the cases of the Cadential 6/4-chord, the Neapolitan sixth chord, and chords with a added sixth, the fundamental bass is the same as the real bass.
4. Augmented Sixth Chords: For all types of augmented sixth chords, such as Italian, French, German, the fundament bass is identified as a tone, a diminished fifth below the real bass.

To phrase it differently in reference to the stack of thirds, the fundament coincides with the root for the French chord. For the Italian and German chords, we follow the same reasoning as the diminished chords, whereby the silent fundament is a major third below the root.

5. Ambiguity: Sometimes the vertical dimension alone does not provide enough information to determine the fundamental bass properly. In this case, the context puts the default choice into question. This can happen with half diminished chords, or the so-called common-tone diminished seventh chord on #II in Major.

6. Upper Structures: Many late romantic and jazz chords need to be interpreted with care in their context (Tristan chord, Eulenspiegel chord, half-diminished chord as an upper structure of an altered dominant, tritone related dominants etc).

Depending on the pedagogical situation, one can go into details or leave the choice of the fundament to the intuition of the players. It is advised to play exercises in the beginning with chords in root position. However, when we consider the alternative possibilities for the bass, it becomes very interesting as shown in the following examples of a first mode in C:

↓ ↙ ↓ ↓ ← ↓ ↓ ↓ ↓ ↙ ↓ ↓ ↓
 T S D T T S #S D T T S #S D T

In the first example, the subdominant is followed directly by the dominant chord. This is indicated by the *left-down* symbol. In the second and third examples, the subdominant chord with fundament F is followed by a chord with fundament D (*left arrow*), which is consistent with the "altered" nature of the tonal function. The notation #S can be used here to indicate the altered (or intensified) state of the subdominant function. We find respectively a secondary dominant for V and an augmented sixth chord, which both approach the dominant with more tension than the regular S chord with fundament F.

Learning from the Masters

Analyzing music is of the utmost importance. We can learn to structure harmony in a natural way by studying and copying the great examples of the masters. For the improviser, it can be a great exercise to analyze the fundamental progressions of an excerpt and then proceed to improvise on the same path. Each time there can be variations of materials, meter, key, etc. I will give one specific example here from the beginning of Schumann's *piano quintet in E-flat major*. Listen to the following audio file:

<http://www.strongspace.com/shared/wr6yueplyp>

[AUDIO] *Schumann Piano Quintet, beginning*

After the presentation of the main theme on a pedal of the tonic, the music continues with a new phrase modulating to B flat major. Afterwards, there is a partial restatement of the theme in the dominant key:

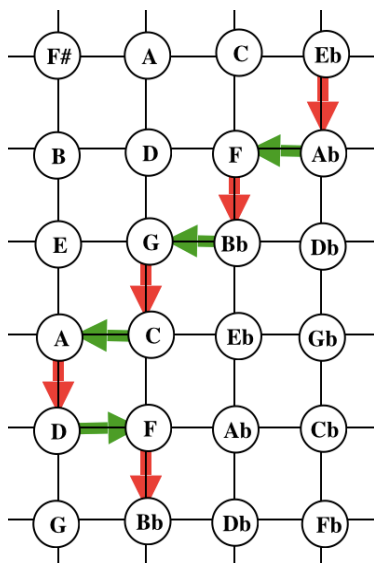

The path from E flat to B flat is particularly interesting. Schumann uses the model of the Monte sequence to literally travel out of the key of E flat. The sudden move to the *right* from D to F takes us out of the sequence straight to the dominant-tonic progression of B flat.

Overview of Most Common Movements

The key concepts of harmonic movement are: prolonging a tonal center, moving between tonal centers (or moving freely), and consolidating a tonal center. This is largely in tune with Caplin's concepts of prolongational, sequential and cadential harmony (Caplin, 2001). In the following catalogue I have tried to create a *Gradus ad Parnassum* of harmonic movements, reflecting the elegance of the simplified Weber space.

Pendulum

Analogous to Gárdonyi's classification (Gárdonyi, 1990), we can talk about the *authentic* and *plagal pendulum* in terms of fundament patterns, *up-down* and *down-up*: I-V-I is the most common, I-IV-I is less common but becomes more used in the nineteenth century:

pendulum



up - down



down - up

Passing movements

In the progression I - VI - IV, VI is not active, but it passes on to the IV. We can see this as the *right* element of the *right-down* arrow that compensates the *left* movement before it. In the progression I-III-IV in minor, III is also not active. In a major key, III takes on the tonic fundament and is also not active. Instead, it functions almost like an extension of the tonic (or even tonic seventh with non-sounding root)

passing movements: I - VI - IV / I - III - IV



Circles

The smaller circles are the *fast turnaround* and the *turnaround*. They have more potential to function like prolongational devices than the longer *diatonic circle*. Examples: Schumann Kinderszenen no.1, Rhythm Changes.

circles



Here one can see clearly how the ascending major second and descending minor third accommodate a progression of falling fifths in the authentic direction.

The full diatonic circle consists of six falling fifths and a tritone shift (*double left*) to close the circle. This shift occurs usually between VII and IV in major and between VI and II in minor:

circles: full diatonic

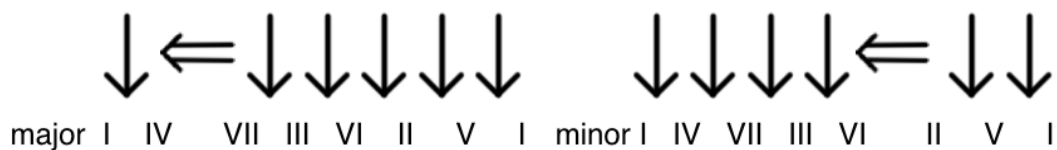

A full chromatic circle (12 descending fifths) is very rare. There are only a few pieces using it. An interesting example to mention is the jazz-standard *All the things you are*, which does use all twelve fifths but not in a straight circle.

Special circles

A special circle is created by the combination of the so-called *Monte* and *Fonte* sequences (patterns from the Partimento tradition). A stepwise ascent (combination of a falling fifth and

a descending minor third) raises the harmonic tension, followed by a release of falling fifths. This usually occurs in a major key but can also work on corresponding degrees in minor. It is a fun pattern to experiment with, as there are many choices possible for the chord forms and inversions.

special circles: Monte followed by Fonte

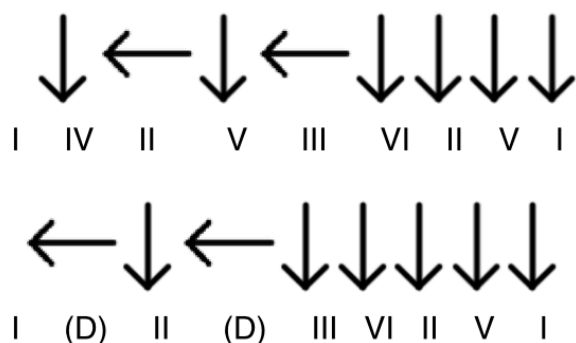

There is a particularly beautiful example of a Monte sequence in Bach's famous Air.

Understanding the modes

The modes are in fact circles that have been embedded into tonality. Early experiences with teaching piano students show that the rather theoretical concept of the modes is not directly enlightening for them. Clearly more thinking and experimenting is needed here. This is the graph I used for the students when speaking about establishing and prolonging a key area:

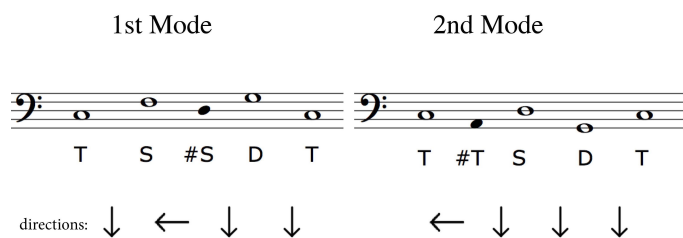

The first mode is also called the *cadential mode*, since it functions very well to make a final gesture. The second mode is called *prolongational mode*. Since it shares the same notes with the first mode of G, it functions as well to make a half cadence gesture or to modulate to the dominant. Afterwards, an immediate return to the original tonic is always possible.

Patterns on the grid

There are many patterns on the grid which are interesting, but they are not necessarily very useful from a musical perspective. I will organize a few of them according to their harmonic result:

- **Moving Fifths up:** truncated fast-turnaround, truncated turnaround (modulating fifths up)



- **Moving minor thirds down:** the Needle stitch



A very special version of this pattern is the so called *Omnibus*. It was popular in the nineteenth century and combines a chromatic descending line in the bass with a plagal pendulum. For a detailed description, please refer to the article published in the proceedings of the MCM conference in Paris 2011 (Noll and De Jong, 2011)

- **Moving major thirds down:** giant steps

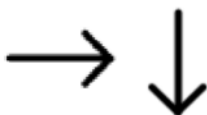

We all know this famous pattern, which can already be found in Schubert and Ravel (Ondine). It consists of an ascending minor third followed by a falling fifth. It creates a closed circle when repeated three times.

- **Moving minor seconds down:** *double-left, down*

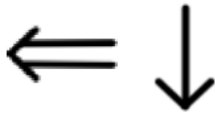

This pattern is particularly effective when played with a bass descending in minor seconds.

- **Other patterns:**

Patterns not mentioned yet: inverted needle, inverted giant steps, half-step up, castle wall, snake up, snake down, the square. And there are many more. It is a very nice exercise to ask students in the class to make up new patterns and find multiple ways to play them.

Double chords on a single root

A particularly interesting phenomenon is a sequence of chords on a single root. I call the color changes on a standing fundament. We find particularly nice instances of this in Chopin's work. He often writes instead of a regular II - V7 - I progression: II (major) - II4/3 half diminished - V7 - I. Another common instance is a dominant which first moves to its tritone related dominant before resolving (as it is often employed in jazz).

Little improvisation journeys.

As an exercise, one can design little journeys beforehand and play them. For example:

- Start in D minor and prolong the tonic, then modulate to F major using falling fifths and consolidate this new tonal center with a tonic prolongation. Now make a harmonic sequence with left, down patterns until you reach the dominant of the original key. Prolong this dominant to prepare the return to the beginning. Repeat the beginning shortly and then end with a Tonic prolongation.

- Start in F major and prolong the tonic, then modulate to the dominant with a truncated turnaround. Continue with two giant step sequences, then make *double-left down* sequences until you reach the dominant C. Improvise an ending.

These types of journeys can be very precisely defined or left more open. They are a good way to practice one's navigation skills.

A way forward

There will never be a complete, all-in-one solution. However, spatial representation of the fundamentals of harmony and the melody of the fundamentals can function as an effective guideline during playing. Because it does not define and rule all aspects and because of its *limited specificity*, it gives the freedom an improviser needs to express their ideas.

There is no doubt that much more inspiration can be taken from my sources. The case study and the ensemble project as described in the following chapters do not represent a conclusion. Instead, they illustrate the beginning of many ways to explore new pedagogical directions.

The Modulation Project: A Case Study with Pianists

Introduction

In line with the concept of "navigating" through harmony, the idea occurred of a project in the form of a case-study that would investigate how to teach the creation of logically moving harmonic progressions. In other words, rather than improvising thematic phrases that stay in a fixed key, the student would learn to improvise unstable harmonic progressions, harmonic movement and modulation. When modulating from one key to another one needs both the ability to establish and consolidate a tonality (origin and destination), and the ability to move from one key center to another. How this moving is actually done has historically been described and approached in many ways, but in fact the possibilities are endless. Many factors come into play, from stylistic habits to rules in textbooks and the idiosyncratic ways of composers. In the nineteenth century the German music theorist Carl Friedrich Weitzmann apparently remarked that "any chord can follow any other chord", which would render any modulation theory useless. A little less radical one could say that some modulating passages are more *goal-oriented*, as opposed to passages where the journey itself is more important. Often in the nineteenth century the fast and chromatic paths were favored (think for example of the writings of Max Reger on modulation), whereas in the eighteenth century we find sources like Johann Friedrich Daube (Daube, 1756) which describe more the path between two key areas. To be able to understand more of how modulation works in improvisation, and how it can be taught, it was decided to set up a small study with two groups of piano students of the Royal Conservatoire of Den Haag.

Case study

In the case study I wanted to test my own pedagogical idea's against at least one other. This is where my colleague Bert Mooiman came in. As Bert is a highly regarded improviser and working on a dissertation about improvisation in the nineteenth century, a unique chance to collaborate presented itself. After discussing this possibility we decided to set up a case study in such a way that both our research projects could benefit from it. We also decided that the study should by no means have a scientific character. Differences in the pedagogical approach would have to be defined quite freely, and the results would be evaluated and interpreted in a qualitative way. Since Bert was studying extensively the sources of Kalkbrenner (Kalkbrenner, 1849) we called his approach the *common tone approach*. The

other approach would have to use the simplified Weber space, arrows and functional modes, and is called *the directional approach*.

Organization

For the study we engaged eight students of our piano department. They were all principle piano students of various levels in their Bachelor studies. We divided them into two groups: group A would be taught during 5 classes of 30 minutes with the *directional* approach, group B would be taught during 5 classes of 30 minutes with the *common-tone* approach. Bert and I would alternately be teaching both groups, to rule out that the specific characteristics of one single teacher would influence the results too much. All lessons were recorded, so that they could be more easily evaluated.

Content

In the study two different pedagogical approaches have been used. The first group would be starting with the Weber Space, Arrow Symbols and Functional Modes, while the second group would use a common nineteenth century approach inspired by Kalkbrenner's *Traité d'Harmonie du Pianiste* (Kalkbrenner, 1849). For easy reference we will call them from now on the *directional* and the *common-tone* approach.

A detailed description of the steps followed is published in the subsequent chapters on the actual lessons. The global planning before the start of the classes was as follows:

Group A, *directional approach*

Use of Weber space, arrow symbols and functional modes:

- 1) Exploring the Weber grid by playing free *paths* on the grid.
- 2) Adapt the choice of the harmonic background to the directions taken.
- 3) Making simple modulations by following a path from one tonic to another
- 4) Exploration of the functional modes, learning how to establish and prolongate a key area
- 5) Modulation by finding ways of connecting functional modes of different key areas on the grid.

Group B, common-tone approach

1. Playing, understanding and transposing examples of Kalkbrenner.
2. Free modulating chord connections with one or more common notes (slow, arpeggiando).
Goal: practicing thinking in common note connections.
3. Tonic triad contains a note from V7 of new key, new key to be established with authentic cadence.
4. Triad on V contains a note from V7 of new key. Modulations like in examples Kalkbrenner; new key to be established with authentic cadence.
5. Triad on IV contains a note from V7 of new key. Modulations like in examples Kalkbrenner; new key to be established with authentic cadence.
6. Modulating sentences starting from incipits, following steps 2 – 4 and eventually free modulations. Antecedent – consequent or free phrase structure. Awareness of essential tone(s) in the new key.

Organization

There will be two Two test groups of four students each. The participants are principal piano students of various levels in their Bachelor studies. They are divided in two groups, one that will always work with the *directional approach*, and the other with the *common-tone approach*. The two teachers involved teach both methods to avoid qualitative differences based on the teachers. The total duration of the test phase is five sessions of thirty minutes. All lessons are registered (with permission of the students) to be used for internal qualitative analysis of the study. The video materials will only be made available to those directly involved in the process.

Evaluation

For evaluation a selection will be made of clips from the video that illustrate the key points of the lessons. There will be observations on the learning process, difficulties, teaching process and method. General observations of Bert and Karst are independently contributed.

Group A, the directional approach: video materials, descriptions and observations.

I do not intend to transcribe the full content of the lessons here, but wish to select the most relevant parts of each class and discuss what happened in the light of the teaching and learning process. The descriptions follow roughly the time path and development of the lessons.

Group A, 17 November 2014, teacher Karst (K=Karst, N=Nastya, G=Gabriele, B=Bob).

The first question is in how far the students have had any instruction on the subject of modulation so far. N: We did it normally by hearing. There were rules, but I don't remember them. G: we learned a few types, the one with the dominant 2nd chord and with the diminished 7th chord. But it is all blurred now. B: I have had no lessons on this subject so far.

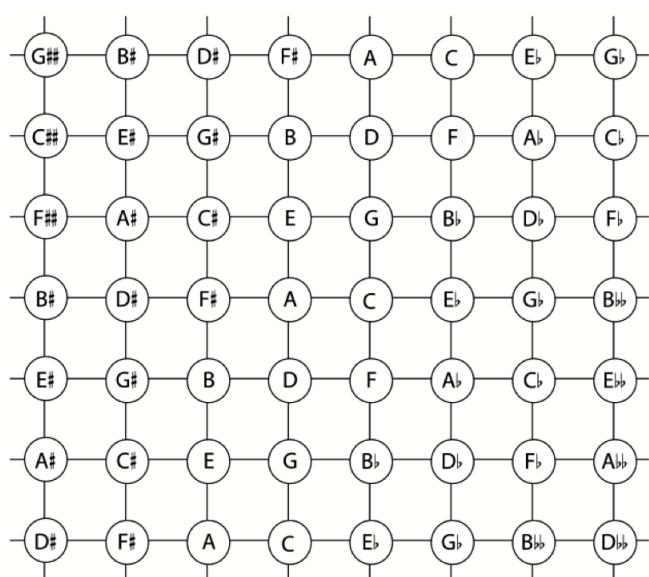

Simplified Weber Space

One copy of the grid (simplified Weber Space, see above) was put up on the piano, and each student received one to take home. The idea behind the directions in two dimensions was explained. Why perfect fifths and minor thirds? There appears to be a minor and a major side of one and the same selection of tones (diatonic scale), sharing the same circle of fifths. I

played examples of this, showing the importance of the falling fifth, and the kinship of I and VI, the major and minor as related keys:

<http://vimeo.com/126744518>

[VIDEO NTH0758A (5:40)] Demonstrating the relative major and minor on the circle of fifths.

The students were asked to play a free "path" on the grid. I explained that grid notes represent fundamentals of the chords, so any major or minor chord on the root indicated in the grid is possible (to keep it simple for now). To avoid falling off the grid, one can jump to an equivalent fundament when nearing the border of the grid. Here is a video excerpt of Bob following a free path with a limited number of chords:

<http://vimeo.com/126741658>

[VIDEO NTH0758B (11:43)] Bob

While trying this N remarked: "I have to think about major and minor". She is addressing a very important point, which has deliberately been left out in my research with Thomas Noll so far, but which is inevitable in relation to practical teaching. My initial answer is that a student needs to rely on musical intuition, and experiment with different possibilities (In my meeting with Peter Schubert at McGill, he stressed the importance of *playing in the sandbox*). It also helps to try to keep the chords compatible in the diatonic as far as possible. We should not forget that there is a great amount of freedom in the choice of chords, as most rules in this direction are based on the aesthetics of a certain style. One concrete thing one can do is to anticipate the upcoming harmonic direction. The chord types can be adapted to the situation: anticipating a falling fifth means that the chord chosen can be a dominant 7th, or the chord already chosen can be changed to a dominant 7th before making the falling fifth progression. Practicing this also greatly stimulates the active aural imagination: rather than playing chord by chord one imagines a sequence before actually playing it. Here is an example of G trying to do this:

<http://vimeo.com/126741661>

[VIDEO NTH0758C (17:32)] Gabriele

In a Left progression followed by a Down, the voices can either stay (major goes to minor^{7th} and minor goes to half-diminished 7th) or there can be a rising chromatic line when the Left becomes a dominant 7th.

Think about the possible paths within a diatonic situation. For example in C major one can go down a fifth to F, but not more than that, because B \flat is out of the key. So a typical path is C-F-D-G-C. After the F comes a shift to the left rather than a falling fifth. The result is a typical classical cadence: I – IV – II – V - I.

Discovering simple patterns, N playing C-A-D-G-C and repeat. Confusion over bass note versus fundament (II65).

<http://vimeo.com/126744519>

[VIDEO NTH0758D (20:23) Nastya

Group A, 24 November 2014, teacher Bert (B=Bert, N=Nastya, B=Bob, W=Wouter).

The lesson starts with playing free improvisations following paths on the grid. Bob is clearly more comfortable doing this than he was in the first lesson:

<http://vimeo.com/126739540>

[VIDEO NTH0030A (0:02)] Bob

Interesting to mention here is that Bob apparently said to Bert that this way of connecting chords matches what he already likes to do by himself while improvising. One can notice also that in this improvisation he has a preference for movements *up* and *right*, which gives the improvisation a distinct 'pop' like feel.

Regarding the grid on the piano A remarks "It is easier somehow when I don't look at this paper". This means the grid must be internalized, fundament connections need to be heard, seen and felt on the piano. Right now she finds it hard to keep playing while following the path on the grid. W finds it extremely difficult to do more than just playing single chords while moving about the grid. He lacks the ability to create movement and keep playing while anticipating chord changes. For this type of student we need to work on very basic patterns, like moving back and forth between tonic and dominant, before we can go further.

Bert asks now from the students a first try to play a modulation following the next steps: choose a starting key and consolidate the key, then follow a path towards new key, then consolidate this new key. The first assignment is to modulate from A major to B flat major. It sounds simpler than it is, as W is struggling to find a convincing way. Bert shows a possible solution in this short fragment, following the path A-C-F-Bb:

<http://vimeo.com/126739541>

[VIDEO 0030B (18:09)] Bert

Just like I did in the previous lesson, Bert points out that changing a chord into a dominant enables the *down* progression, while changing from major to minor opens the way to the *right* movement. However to make a more convincing modulation, it works often better to make a II-V-I progression than to just play a chain of dominants.

Now to make it sound a little more musical Bert proposes to take a Scottish folk-song as input. Play the theme in F major and then make a modulation to A major. Two of the possible paths are: *double-left* and two times *down*, or *monte sequence left, down, left, down*. Bob uses the latter:

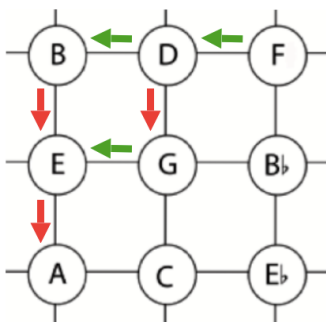

<http://vimeo.com/126741653>

[VIDEO 0030C (23:23)] Bob

Group A, 1 December 2014, teacher Karst (K=Karst, B=Bob, W=Wouter).

We start discussing the relationship between fundament and bass note, as well as chords with "non-sounding" fundaments. The dominant 7th chord (on the fifth note) and the diminished 7th

chord on the leading tone have the same fundament: their harmonic functioning is equivalent. Thus the diminished 7th chord can be regarded as having a non-sounding fundament which lies a major third lower. We recuperate some things from the previous lessons. W has a tendency of playing major chords on each and every fundament. We discuss why this does not work well. One has to try to make sensible upper structures that fit into the diatonic world above the fundaments. Trial and error is one of the strategies: this will train the aural imagination so that the right chords will be anticipated. This is an essential skill for improvisation. B is clearly ahead of W in this respect.

Next W is asked to play a modulation from C major to E minor. The following happens:

<http://vimeo.com/126744520>

[VIDEO 0772A (18:40)] Wouter

He decides on the path C - A - F# - B - E. However, there is doubt about the exact voicing of the chords. It is interesting to see that with a little trial and error he finds a correct melody, after which he can think about adding the other notes of the chords. I think this is an important learning moment.

W is still confused about the difference between bass and fundament. I offer a more elaborate explanation to clarify the situation, using an example from Beethoven:

Adagio cantabile.

The image shows a musical score for the first few measures of Beethoven's 'Adagio cantabile'. The score is in 2/4 time and E-flat major. The bass line is marked with a piano (*p*) dynamic. Below the bass line, there are seven arrows indicating the direction of movement for each note: up, down, up, down, left, down, down. The notes in the bass line are: E-flat (finger 4), G-flat (finger 2), A-flat (finger 1), B-flat (finger 4), A-flat (finger 4), G-flat (finger 3), and E-flat (finger 2). The treble clef staff shows the right hand playing chords and moving up and down.

As one can see, the underlying pattern is simple, initially just *up* and *down* prolonging the tonic, then moving to the dominant via *left*, *down*, *down*. Most of the chords are inverted to create a more melodic bass line. First and last chords of the phrase however are in

fundamental position, clearly marking the main tonal functions. Gaining control over one's improvisation in this way is definitely a more advanced skill.

Group A, 8 December 2014, teacher Bert.

This class was a private class of Bert to Bob. At the beginning Bob received a copy of the modal charts, which looks like this:

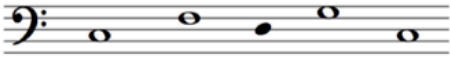
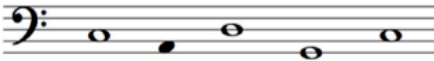
| 1st Mode | 2nd Mode |
|---|--|
|  |  |
| directions: ↓ ← ↓ ↓ | ← ↓ ↓ ↓ |
| Cadential mode | Prolongational mode |

Functional modes

It was explained how the cadential and the prolongational modes are two very common paths followed in the Classical and Romantic style. They can both be used to establish a key area. The fundamentals are designated as Riemannian Tonic, Subdominant and Dominant functions. The altered Subdominant in the Cadential mode and the altered Tonic in the prolongational modes are optional. They can be used to intensify the harmony before the change to the next function (see also the more extended explanation in the chapter 'Sources I').

Bob initially explores the modes in various keys. Bert suggests to make a modulation by switching the #T in the second mode to the S in the first mode of the new key. It takes Bob a while to understand the concept. Eventually he plays in D major: I - VI and reinterprets the last chord as F#-minor IV, continuing with II - V - I. Translated to degrees of the functional modes this could read as: D: T, #T = F# S, #S, D, T. So far this works fine. Bert continues with presenting some 'beginnings', basically 4 bar *antecedents* that should be completed with

a modulating *consequence*. Bob decides to modulate from C major to E flat major with this given beginning:



See and hear what happens the first time:

<http://vimeo.com/126786371>

[VIDEO NTH0231A (00:00)] Bob

Here B starts the second half of the phrase with a Bb major chord, which is quite far from the C major chord at the end of the first phrase (*up-left*), as a result the phrases feel disconnected. Bert remarks that the B flat also is not a shared note in the modes of C and E flat. There has to be a better way. This is his second version:

<http://vimeo.com/126786372>

[VIDEO NTH0231B (12:16)] Bob

Now the path is more elegant, the T at the end of the first half becomes the #T in the key of E flat major, and consequently moves to an f minor chord. In a more advanced stage one will be able to make fast choices about alternatives which share the same path, such as replacing the F minor chord with an F half-diminished, creating a chromatic passing bass note C flat (E flat: II43 moll-dur), or to change the C major chord first to C minor before moving on.

Bert rightfully stresses a few times the importance to be able to change color on the same fundament. Without this the upper structures will not fit into the new key area. The student must not only follow the path but also anticipate the new key with the choice of chords.

Group A, 15 December 2014, teacher Karst (K=Karst, N=Nastya, G=Gabriele, B=Bob, W=Wouter).

This week the group is complete. We began with discussing the chart with the modes and practicing to play elementary versions of these modes in various keys. It can be observed that the first mode of C coincides with the second mode of F. To the other direction the second mode of C coincides with the first mode in C. The only difference there would be is the type of chords one plays on these fundamentals. One can modulate easily fifths up and down with these common fundamentals. To illustrate this we try a few modulations on fifth distance:

<http://vimeo.com/126815851>

[VIDEO NTH0813A (12:42)] Gabriele

The easiest path to follow when modulating a fifth up is: *left, down, down*. To modulate a fifth down one can follow: *down, down, left, down, down*. Of course there are many other paths possible. The students are still a bit confused about the difference between the first and second mode. For now I try not to be too specific: the pattern is the same, and they are simply two different paths one can follow to stabilize a key area. The 'alteration' (black note in the graph) is optional. So for a second mode one can play: I - II - V - I, or I - VI - II - V - I. Inversions and secondary dominants are also possible, as long as they are based on the same fundamentals of the modes (see also the examples in the chapter 'Choosing the chords').

We discuss some other common modulations such as the modulation to the relative minor key. The goal is to quickly imagine the patterns of the modes in relation to a key. Common fundamentals can be the stepping stones between the key areas. We discuss this and Nastya plays a modulation from C major to A minor:

<http://vimeo.com/126844161>

[VIDEO NTH0813B (25:18)] Nastya

With this class the series of 5 lessons ended. A further evaluation follows in the chapter after the lesson descriptions of group B.

Group B, the common-tone approach: video materials, descriptions and observations.

I don't have the intention to transcribe the full content of the lessons here, but wish to select the most relevant parts of each class and discuss what happened in the light of the learning process.

Group B, 17 November 2014, teacher Karst (K=Karst, E=Eunike, Mc=Michelle, T=Tobias, Mk=Mekhi).

After a short introduction of the subject and goals of the class, I asked in this group also to which extent they have had any instruction on the subject of modulation so far. E: not really learned about it, except how to go from the major to the relative minor. (K: just a related question, which are the modulations always made in tonal musical structures? Of course from major key to it's dominant, and from minor to it's relative major key). Mc: last year we were taught about modulation, something with going from E major to E flat, but I don't remember. It was written on paper. T: we haven't learned yet with writing. Mk: I actually just started with music theory classes.

We will explore the so called common-tone approach, as described in the previous 'setup' chapter. The first exercise is to play random progressions of chords which have exactly one tone in common. The chords don't particularly have to be in one key. Watch the first attempt of E:

<http://vimeo.com/126739535>

[VIDEO CT0760A (6:40)] Eunike

In the beginning E is not making the distinction between chords with one or two common tones. We evaluate and see that chords on a third distance such as I and VI have two common tones. Triads a fifth apart have just one. The dominant 7th chord in fundamental position with four different tones will not allow for a common tone with its resolution. In this case doubling the bass note (and leaving out the fifth) creates a common tone. Now we compare the progression C-major to a-minor with C-major to A flat-major. There is more surprise in the latter. This is a connection of two chords on a third distance with a single common tone.

Something else to consider is to consciously put the common tone in a certain voice. When put in the melody, it is particularly effective, while in the middle voice the connection is less obvious. It is clear that the students do not feel confident at this stage, there is simply too much thinking going on. This will undoubtedly improve with experience. As no one came up with the possibility yet, I showed some examples of creating the common tone in the bass:

<https://vimeo.com/126739538>

[VIDEO CT0760B (14:32)] Karst

Next is T at the piano. Although he still needs a lot of time to think we can observe that he starts to feel more confident, and show more creativity in the choice of his chords and progressions. At some point he is even shocked by the 'unexpected' sound of an augmented chord. This is an important part of the exploratory character of the exercise. Even experienced improvisers are sometimes surprised by things that happen faster than what they expected with their imagination, and learn to deal with it:

<https://vimeo.com/126739539>

[VIDEO CT0760C] Tobias

Group B, 24 November 2014, teacher Bert (B=Bert, E=Eunike, Mc=Michelle, T=Tobias, Mk=Mekhi).

Bert starts with an improvisation assignment: play a prelude where there is always one common tone when moving to the next chord. Try to always keep moving. If in doubt just repeat your chord before moving on. Enjoy the sound and the quality of the chords while playing. The first attempt is made by Tobias:

<http://vimeo.com/126851819>

[VIDEO CT0032A (00:04)] Tobias

The common tone rule creates a natural connection between consecutive chords, where the improviser has the choice to create low or high contrast between them. It depends on the

strength of the aural imagination to which extent there is control over this amount of contrast, as well as over the grouping of the chords into certain tonal area's. In Tobias's prelude there is a certain randomness which makes the listener get lost after a while. On the positive side there is good concentration, he plays without interruptions and makes a nice sound.

The next assignment is to take a similar approach but make a modulation. E is invited at the piano and makes modulations by sequence with a particularly nice contrasting connection of F minor to E major with the common tone in the melody. However, there is not much focus and it moves in many directions. Bert asks her to be more concrete and start in F major, then modulate to A major. Eunike does not really find a convincing way of doing this. Bert suggests that a more regular phrasing might help, and proposes to use a Scottish folk song as a starting point. This is Michelle's version:

<http://vimeo.com/126857240>

[VIDEO CT0032B (22:48)] Michelle

Eventually the sequence moving each time a fifth up gets her there! However, the song gets lost as there is no material used, nor is much left of the original goal to use common tones to achieve the modulation. Bert ends the class by playing some of the modulation examples of Kalkbrenner's book, asking the students to prepare them as homework.

Group B, 1 December 2014, teacher Karst (K=Karst, E=Eunike, Mc=Michelle, T=Tobias, Mk=Mekhi).

In this lesson we discuss the modulations to nearby keys. The first assignment is to go from C to G. Eunike plays the following:

<http://vimeo.com/127391176>

[VIDEO CT0773A (01:42)] Eunike

She plays in fact a whole song, using first a Pachelbel pattern to confirm the key of C, then moving to G through VI6 with the common tone A between CVI6 and GV7. I remark at this moment that Kalkbrenner would probably look for the common tone between the Tonic of C

and the Dominant seventh chord of G. This would have to be the C itself, which changes from a perfect consonance to the expressive seventh of the dominant for G. E quickly picks up this new information. We discuss how the same process would bring you from the key of c minor to the key of g minor.

The next assignment is to modulate from C major to A minor. Initially T is using the E as a common tone of the C major chord and the V7 in A. This works fine, although his attempts lack a convincing consolidation of the key. After some trying he comes up with another way which works quite nicely:

<http://vimeo.com/127857925>

[VIDEO CT0773B (16:35)] Tobias

The next assignment is to modulate from C minor to E flat major. Mk tries but lacks so much basic experience with keyboard harmony that he can not find a convincing way. Looking for common tones between the tonic of C minor and the V7 of E flat he discovers that there are none. We discuss how in this case a common tone can be used from the IV or the V in C. F minor has two common tones with the V7 of E flat, so it is a good candidate for a fluid modulation. We practice both modulations to the relative minor and major starting from a few other keys.

Group B, 1 December 2014, teacher Bert (B=Bert, E=Eunike, T=Tobias).

Bert discusses a few examples of Kalkbrenner's book (Kalkbrenner, 1849). He asks T to play a few examples and comment at the same time on the things happening. The approach is very practical, just looking for common tones which will allow a fluid modulation to the new center.

Now they continue to improvise a consequence on a given antecedent in F major. First one that establishes the key of F, then a consequent that modulates to A major. T is at the piano and hesitates, looking intently at the keys. Bert remarks that it is not his intention to make T calculate and asks him to first play a cadence in A major. Next T makes a first attempt to modulate:

<http://vimeo.com/127871314>

[VIDEO CT0232A (12:46)] Tobias

It is interesting to see that he gets there, but not with the *common tone approach* but rather a *monte sequence* which makes twice a step up from F to A. It may be that this kind of pattern is more intuitively accessible than the calculation that needs to be made. The real solution lies of course in the active imagination; varying on the melody in the antecedent one can for example play the motive up and choose the C# as a goal in the melody, thereby arriving easily in A. It is clear that we need more time with our students to achieve this.

With this fragment we arrive at the end of the report of group B. In the next chapter there is a summary of observations and conclusions of the study.

Observations and Conclusions

Evaluation of both groups

It is striking to see the difference between the abilities of these students when performing practiced repertoire or being asked to play a relatively simple modulation with either method we were using. Little has been taught about modulation, and if it has it was for writing harmony. Many students remarked they did receive some theoretical instruction about modulation in the past, but they had forgotten it. This is significant and problematic, because we have wasted a quite a bit of energy for basic instruction which got in the way of our planned methodologies. Also somehow existing knowledge is not easily converted to a practical approach. Something else seems to be needed: a minimum experience with improvising. Observing the first group, one can see that B is the most skillful and learns the fastest. But he has no theoretical background, only some experience improvising on the piano by himself. As B remarked: "this matches what I already like to do by myself while improvising". This could lead to the conclusion that we need the younger generation of musicians to improvise already long *before* they come to the conservatoire. It pleads for a very practical *hands-on* approach in the early stages of music teaching: training inner singing, *forward hearing*, singing and playing, and control of the instrument guided by the ear.

Observations and conclusions for group A

- There is some confusion about the differences between fundament, real bass, chord and key. This needs to be addressed properly.
- Modal charts may cause confusion because it is not clear what the distinction would be. The student find it also hard to understand the designations #T and #S. Better terminology and methods have to be developed to make use of the modes in teaching.
- Compatibility with the diatonic environment and current key area is important. It's not just the path but also the color of the chords on this path. As remarked earlier on in the future an integration of directions with voice-leading principles should be established.
- The grid must be internalized, fundament connections need to be heard, seen and felt on the piano. One needs to develop the skill to use inversions appropriately to the situation instead of always putting the fundament in the bass.

- While going we discovered some advanced rules: Falling fifths may be replaced by chromatically descending fundamentals. Before falling a fifth one may change the chord to a dominant. Left progressions (descending minor thirds) can go together with introduction of a chromatic leading tone in the upper voice. Right progressions (ascending minor thirds) can be anticipated with a minor chord, or by changing first a major chord to minor.
- Bert remarked: "I believe that this approach has the potential to open up harmonic possibilities, but that probably demands a much deeper insight from the students than they really had. The method invites to explore the vast area of harmony, but only who knows already the basics will find this enjoyable."

Observations and conclusions for group B

- About the *common tone approach* Bert remarked: "What fascinated me was the directness and, in a way, simplicity of this modulation method. Within this short project, the students didn't get fluent enough to use it musically: it remained something arithmetical to them, there was no 'ownership'. I would be very curious to see whether a longer period of teaching could improve this"
- This is indeed a powerful way to quickly modulate to any other tonal center, however there is also a risk of just jumping to a new key with little elegance and lacking a sense of movement toward this new key.
- Too much calculation involved. The students are staring at the keyboard to find common notes instead of actively imagining them, and the line they could make towards the new key.

Comparison of both approaches

There is an obvious overlap visible in the approaches, especially with closely related keys. For example a modulation from C to G: the *directional approach* would change C2 mode for G1, leaving all options open for the choices of the chord-types. The *common tone approach* would use the tone C as a common tone between C1 and G1, effectively resulting in a similar path (I - II - V)

Conclusions

- Something needs to be said about upper structures, which would be more than "use your musical intuition".
- Include analyses in the lessons to show how great composers make modulations. Use literature they know well.
- None of the approaches really says anything about how to integrate thematic and motivic elements in to the modulation, that would also go much too far for this kind of study. Traditional books on modulation have always been guides for the composer, not for the improviser. It helps to take "incipits" as starting points for the improvised modulations.
- It is interesting to notice how experience with trial and error can give an advantage. Any improvisational activity that relies on the ears will establish a better connection between the improviser and the instrument. As Bert remarked: "with regard to the level of the students, especially the real beginners were interesting to me. In my view, the benefit of starting to make music by trial and error was demonstrated by B, who - despite his rudimentary harmonic knowledge- was in fact one of the most successful 'modulators'.
- We need to bring the level up in an earlier stage, which would make it possible to work with these students on a real musical level, one were the genuinely important issues can be discussed and tried.

Improvising with an ensemble: conducting and managing harmonic directions

Description

As one of the other important future goals for my teaching, I want to develop methods for working on harmony with ensembles of mixed instruments. At the Royal Conservatoire of Den Haag we have radically changed our theory curriculum in the past year and one of the new subjects is called *aural skills and improvisation*. The working form that students with mixed instruments are participating by playing together in an ensemble. It is exactly in this subject that new strategies and methods of working could be a welcome addition. At present I work in various ways on harmony, integrating Partimento materials into the classes as well as working more traditionally from fixed chord schemes. However, I envision a way of working where the actual harmonic progressions and development of an improvisation are in the hands of the players themselves. A way of improvising which allows for greater flexibility, and which forces the players to listen extremely well to each other, take full responsibility for the way they respond and anticipate their actions while listening. This should lead to an active imagination of harmony and harmonic changes. A small first step in this direction was for me to recently start experimenting using the grid and the arrows as an input for the improvisations.

So far the experiments were:

- Exploring the grid by slowly playing paths. Then with a free improvised voice against the path and playing patterns on the grid
- Strategies for conducting: RH meter, LH fundamental melody. Trying out ideas and developing them. Ensemble as self steering unit.
- Making the rules: the ensemble can make rules about rhythms, ornaments, thematic materials, roles of instruments etc.

And last but not least: everything should be played with attention to the quality of the sound, creativity, and let's not forget to have fun!

A Workshop in London



Workshop at the Milton Court Concert Hall with students of David Dolan.

On 27 February 2015 I gave a presentation and a workshop at the Reflective Conservatoire Conference in London about improvising with an ensemble of classical instrumentalists. The key topics and questions were: How to improvise in a tonal style? What are good strategies and working forms when teaching tonal improvisation to an ensemble? How can monodic instrumentalists work on harmony together? I have found that improvising on patterns or schemata as they were used in the 18th century is a very good starting point. But I wanted first and foremost to try out the idea's behind *Navigating through Harmony*. For this there were two opportunities, a workshop for students of David Dolan, and a presentation in the program of the conference. For the presentation the Guildhall School of Music provided me with an ensemble of students, whom I only met shortly the day before. The materials presented all came into spontaneous existence at the moment and were never rehearsed. The ensemble consisted of three violinists (Katya, Danica and Sophie), two pianists (Sasha and H  l  ne), a flutist (Henri) and a cellist (Naomi). We had two grand piano's on the stage. The presentation was held in the Milton Court Theatre, for quite a large audience.

Music is movement

We started the workshop by exploring a very basic principle of harmonic movement: where parallel triads disrupt the feeling of harmonic unity (each triad acts as a tonic), parallel sixth chords create a sense of movement. Compare I - II - III to I - VII6 - I6. In the teaching methods of Partimento (Gjerdingen, 2005) this principle is basically extended to include sixth chords on all degrees except I and V (rule of the octave). Working with an ensemble on harmony is particularly challenging and exciting because we don't have it all in two hands like pianists do. The first exercise consisted of playing a solo on an elementary bass line: 8 -

7 - 6 - 5 - 3 - 4 - 5 - 1. In the next video all students play one by one an improvised solo part on the chords (unfortunately not all musicians are visible):

<http://vimeo.com/126925377>

[VIDEO RCC1463 (14:38)] Ensemble playing on Bass Line

Two essential skills can be developed this way: awareness of how one moves inside the key area, and awareness of the intervals one plays on the bass notes. And I don't mean here the theoretical ability to name the interval while one plays (now a minor third, now a major sixth...) but rather the ability to experience the level of consonance or dissonance in relationship to the bass note. To feel consciously if one plays octaves or fifths parallel with the bass, or thirds and sixths.

Next we played some patterns in a sequential way. The pattern was the bass line 3 - 4 - 5 - 1. Changing the 1 into the new 3 creates modulations along the circle of thirds. Understandably, the ensemble found this quite hard to do without any preparation. However, Sasha, one of the pianists picked the pattern up very quickly and a spontaneous duet followed through all 24 keys:

<http://vimeo.com/126954566>

[VIDEO RCC1464A (00:43)] Sasha & Karst, Circle of Thirds

Navigating

After this nice warming up we continued to the materials of *Navigating through Harmony*. On the large beamer screen there was a projection of the simplified Weber grid (unfortunately not visible on the video). The students had never seen this before. I explained that in fact, most of the time in tonal improvisation the chords are pre-determined, such as in a jazz standard or baroque ground. The harmonic responsibility of the players is then quite limited. The real challenge would be to improvise together using tonality, but without a predetermined chord structure.

After a concise explanation of the Weber space and basics of the arrow language we make a first simple improvisation together. The movement is restricted to *up* and *down*. One of the

students is the conductor, indicating the directions with the left hand while conducting the beat with the right. Henri is the conductor:

<https://vimeo.com/127070706>

[VIDEO RCC1464B (09:24)] Henri conducting

The sooner the conductor shows the direction, the better the students can anticipate. This stimulates the aural imagination and trains to coördinate the action on the instrument to move towards a new chord. However, it's not just the conductor telling the ensemble what to do, but the ensemble is also influencing the conductor by the notes they play, and the timing of those notes. For example one of the violins adding a minor seventh to the D major chord causes the conductor to indicate a *down*, without maybe even being conscious of it.

The next step is to be free to go multiple fifths *up* and *down*. Sasha is conducting in the following excerpt:

<https://vimeo.com/127088004>

[VIDEO RCC1464C (12:03)] Sasha conducting

Expanding the number of *fifths* up and *down* creates more movement, but we also lose focus, especially since the ensemble plays major chords on each fundament. The effect of this was discussed shortly afterwards. Playing together in this way more often it can for example be decided to stay within one diatonic, and play notes within that single diatonic. Any other set of rules can be agreed upon, including to use certain rhythmical and motivic material.

Now the horizontal dimension is brought into play. I show how the *left* and *down* directions can work together to stay close to the tonic, and create a clear sense of tonality. As a result of me demonstrating these functional mode patterns on the piano the ensemble stays in the key of G, playing mainly with the degrees I, VI, II and V. In the following video excerpt Hélène is conducting, now also using the horizontal dimension:

<http://vimeo.com/127133041>

[VIDEO RCC1464D (15:23)] Hélène conducting

Her gestures are clear and prepared well in advance, so the ensemble feels quite comfortable anticipating the harmonic changes. It is interesting to observe that one of the violinists plays a sixth (note E) in the final chord without feeling the need to go to a note of the tonic triad of G. This is probably caused by the frequent movements between I and VI, and their harmonic closeness. There is no doubt that G6 works well as a final chord, but the question is if the player is conscious of this fact. I believe it is important to discuss these matters in a classroom situation, however on a stage with an audience I did not interfere.

We discuss how the Fonte and Monte sequences from the Partimento tradition are similar to basic movements on the grid. Now we proceed with the full diatonic circle, starting with playing slowly through the circle of the key of a minor. I ask the students to specifically feel the harmonic movement as they go and be aware of the position of the tritone between VI and II. They all know this circle so well that they play improvised solo's on it without any problem. It is ultimately the goal to get to know many of these patterns. With more experience and shifting the playing to come from inner hearing, the more the students will improve their direct control over the instrument, develop confidence, and become proficient in any key. An excerpt from the circle:

<http://vimeo.com/127133043>

[VIDEO RCC1464D (15:23)] Improvising on the circle

Where the pianist is already a little more experienced, the two violinists are making a basic mistake by copying many of the bass notes. This is actually quite common when unexperienced with this way of playing together; the last violinist, while playing a very beautiful solo, unconsciously copies her melody notes from the bass notes (all except the G), creating in fact a line of parallel octaves. It is necessary to let students realize that this is what they are doing, so that they can develop a *polyphonic* hearing capability, consciously aiming for thirds, sixths, suspensions and other interesting notes, instead of doubling the bass.

Observations

First of all working in this way with an ensemble is very enjoyable. The fun and immersion made it a valuable experience. To put the players also in the role of the conductor means they have a chance to experience the harmonic directions from another perspective.

Strictly speaking Partimento is not part of the Navigating materials, but I see a worthwhile connection between the two. When improvising with an ensemble it is a very good method to start improvising from bass patterns. Even though I don't know exactly how at this moment, I feel that Navigating through Harmony can and should ultimately be integrated into the approaches of the Partimento tradition. Many patterns of the Weber grid and arrows such as the Monte and Fonte sequences lie at the basis of Partimento patterns.

It is clearly not easy for players of a monodic instrument to freely improvise a counterpoint against a bassline; all too easily they follow the same line and the result is a heterophonic texture. There is work to do on the integration of theory and practice to achieve better results. A simultaneous training of various aural, theoretical and practical skills is needed.

Conclusions

The journey of exploration and the experiences while improvising together with students and searching for appropriate teaching solutions has been very rewarding. There have been classes where I looked at my watch and realized that class had already ended. Didn't we start just a minute ago? There have also been many moments of doubt. Are they really learning something? Isn't this limiting their creativity rather than expanding it? Aren't we going way too slow? There have also been moments where my students said: "Wow, we have never done anything like this before, and it sounds great!" or "Oh, is this how it works?!"

These experiences have reconfirmed the importance of playing with one's ears wide open while improvising. However, it is a special skill that requires training. For most students, it is very disappointing to understand how lost they truly are without a score or a fixed harmonic plan. They must receive step-by-step guidance on how to become confident and develop their skills to truly express themselves. I believe the navigation system can help them become oriented. They can learn how to make small steps at first and gradually expand their outlook and imagination. The pentatonic nature of most tonal fundamental progressions is a good starting point to learn about how to listen to the bass.

To return to the research question, I can say with certainty that a simpler organization of harmony in the improviser's mind stimulates an active imagination. It stands less in the way of the creative process, and leaves more time to anticipate what lies ahead. This agrees with "the virtue of a lack of specificity," as stated by Ian Quinn. However, it also requires musical input from the outside. By analyzing works from the masters and carrying out many active listening activities, a student can assimilate this input into his/her improvisations. As a teaching tool it is promising, although new materials have to be developed. This is work in progress.

I am also quite optimistic about the potential of the directional approach as a navigation tool: I have observed the following positive signs in the classes as well as during my own experiences:

- Harmonic movement can really be felt as opposed to calculated.

- The arrows are a good tool for invention, they challenge the obvious progressions one makes habitually as an improviser.
- The learning curve is steeper than I had foreseen, but it is rewarding in the end.
- One develops a sense of the basic movements in harmony: prolongation, movement and consolidation.

To apply these new insights and approaches in teaching, we need to make choices not just about the content of the improvisation class, but about the general curriculum for music theory. Certain traditional subjects will need to be reformed or replaced by subjects that start from the perspective of hearing. In my (limited) experience with teaching the new curriculum in Den Haag, I have taught the new subject *aural skills and improvisation* and already observed some remarkable progress in the following areas:

- Playing together without a score
- Aural imagination with inner singing and 'forward hearing'
- Harmonic imagination and a more active understanding of harmony, especially with monodic instrumentalists
- Ability to translate this active imagination into appropriate and timely action on the instrument

Clearly this research is not finished here. The next step is to take results from this research as a starting point for changes in my teaching. First and foremost on my list is the wish to integrate the directional ideas with certain elements from the Partimento tradition. As mentioned earlier in this text, both Partimento and “Fondamento” have very constructive, complimentary qualities which can become more powerful when taught together. Then there is further research needed on the relationship between the upper structures and the underlying *fundamental melody*. This will inevitably deal with stylistic elements such as chord forms and voice leading. In any case new concepts will have to be elegant and not overly specific in order for them to be useful for an improviser. I can only hope this will contribute to our future musicians not just playing music, but playing *with* the music; navigating through harmony by using their ear-pilot instead of simply using their auto-pilot.

Barcelona, May 2015

Acknowledgements

Thanks to Thomas Noll and Michiel Schuijjer for their coaching. Thanks to all students who have participated in the case studies with honesty, curiosity, and great musicality: From the piano department of the Royal Conservatoire in Den Haag: Michelle Chow, Gabrielle Zemaityte, Anastasia Kurilko, Bob Marsden, Wouter van der Lans, Tobias Wentink, Mekhi Ghazaryan and Eunike Indrawan. All ensemble students from the Guildhall School of Music and Drama in London: Danica Smith, Katya Poplyansky, Sophie Poteratchi, H el ene Favre-Bulle, Sasha Millwood, Henri Roberts and Naomi McLean. Ensemble of students of the Royal Conservatoire: Emma Rhebergen, Elizabeth Marr, Vincent Martig en Pieter de Koe. And many thanks to Makiko Nomura for being my greatest supporter.

References

- Caplin, William (2001) *Classical Form: A Theory of Formal Functions for the Instrumental Music of Haydn, Mozart, and Beethoven*. New York: Oxford University Press.
- Carey, Norman and David Clampitt (1989) *Aspects of Well-Formed Scales*. *Music Theory Spectrum* 11: 187–206.
- Clampitt, David and Thomas Noll (2011) *Modes, the Height-Width Duality, and Handschin's Tone Character*. *Music Theory Online*, 17(1).
- Cohn, Richard (1999) *As Wonderful as Star Clusters: Instruments for Gazing at Tonality in Schubert*. In: *Nineteenth-Century Music* 22/3, 213-232.
- Daube, Johann Friedrich (1756) *General-Bass in drey Accorden*, Leipzig.
- Gárdonyi, Zsolt and Hubert Nordhoff (1990) *Harmonik*. Wolfenbüttel: Mösel Verlag.
- Gjerdingen, Robert (2007) *Music in the Galant Style*. Oxford: Oxford University Press.
- Gjerdingen, Robert (2005) *Monuments of Partimenti*. Available at: <http://faculty-web.at.northwestern.edu/music/gjerdingen/partimentil/index.htm> (accessed 22 April 2015).
- Glareanus, Heinrich (1547) *Dodecachordon*. Basel. Reprint: Hildesheim: Olms 1970.
- Gollin, Edward and Alexander Rehding (Ed.)(2011), *Oxford Handbook of Neo Riemannian Theories*. New York: Oxford University Press.
- Heinichen, Johann David (1728) *Der General-Bass in der Composition*. Dresden.
- Henke, Jamie L (1997), *An Historical Survey of the Origins of the Circle: Music and Theory, Musical Insights, Vol. 1*. Available at: www.macromusic.org/journal/volume1/Henke.html (accessed 5 May 2015)
- Johnson, Timothy (2003) *Foundations of Diatonic Theory: A Mathematically Based Approach to Music Fundamentals*. Key College Publishing.
- Kalkbrenner, Friedrich Wilhelm (1849) *Traité d'Harmonie du Pianiste*, Leipzig: Breitkopf et Härtel.
- Klumpenhouwer, Henry (2000) *Remarks on American Neo-Riemannian Theory*. In: *Dutch Journal of Music Theory* 5/3, 155-169.
- Lendvai, Ernő (1995) *Symmetrien in der Musik: Einführung in die musikalische Semantik*. Kodály Institut, Kecskemet, Universal Edition, Wien.
- Lerdahl, Fred (2001) *Tonal Pitch Space*. New York: Oxford University Press.
- Lewin, David (1987) *Generalized Musical Intervals and Transformations*. New Haven: Yale University Press.

Louis, Rudolf, and Ludwig Thuille (1907) *Harmonielehre*. Stuttgart: Ernst Klett.

Mattheson, Johann (1731) *Grosse General-Baß-Schule*. XXX

Meeùs, Nicolas (2000) *Toward a Post-Schoenbergian Grammar of Tonal and Pre-tonal Harmonic Progressions*. In: Music Theory Online 6/1.

Noll, Thomas and Karst de Jong (2008) *Improvising Substitutions in Contiguous Fundamental Bass Progressions*. Dutch Journal of Music Theory, 2008, nr.1.

Noll, Thomas, David Clampitt and Manuel Dominguez (2007) *What Sturmian morphisms reveal about musical scales and tonality*. Proceedings of WORDS 2007, Marseille.
<http://iml.univ-mrs.fr/words2007/>

Noll, Thomas and Karst de Jong (2011) *Fundamental Passacaglia: Harmonic Functions and the Modes of the Musical Tetractys*. Proceedings of the Third International conference on Mathematics and Computation in Music. Berlin, Heidelberg: Springer Verlag.

Noll, Thomas (2009) *Ionian Theorem*. JMM 3/3: 137–151

Quinn, Ian (2005) *Harmonic function without primary triads*. Presentation at the SMT conference, 11 November 2005, Cambridge.

Rameau, Jean-Philippe (1722) *Traité de l'harmonie réduite à ses principes naturels*. Paris: J.B.C. Ballard.

Rameau, Jean-Philippe (1737) *Génération harmonique*. Paris: Prault Fils.

Riemann, Hugo (1874) *Musikalische Logik: Hauptzüge der physiologischen und psychologischen Begründung unseres Musiksystems*. Leipzig: Verlag von C. F. Kahnt.

Sadai, Yizhak (1980) *Harmony in its Systemic and Phenomenological Aspects*. Jerusalem: Yanetz.

Schoenberg, Arnold (1954) *Structural Functions of Harmony*. New York: Norton. rev. ed., ed. Leonard Stein. New York: Norton, 1969.

Weber, Gottfried (1821) *Versuch einer geordneten Theorie der Tonsetzkunst*. Mainz: B. Schott

Zuckerkandl, Victor (1956) *Sound and Symbol, Music and the External World*, vol. XLIV, Bollingen series, Princeton University Press.